



**BELT PUNCH OPERATOR MANUAL**

# CONTENTS

---

1.0 THE PARTS	4
2.0 SETTING UP FOR USE	5
2.1 FITTING THE DISCS	5
2.2 FITTING THE PUNCH AND DIE TO THE MACHINE	5
2.3 FITTING THE BELT	6
2.4 SETTING THE BELT TENSION	6
3.0 PUNCHING WITH THE MACHINE	7
3.1 PUNCHING METHOD	7
3.2 PUNCHED BELT	7
3.3 FINISHING THE BELT	7
3.4 TWO LINE PUNCHING	8
3.5 PUNCHING METHOD TABLE	9
3.6 PUNCH AND DIE SIZES	10

# 1.0 THE PARTS

This manual will take you through the setting and operation of a Stanhay Belt Punching machine.

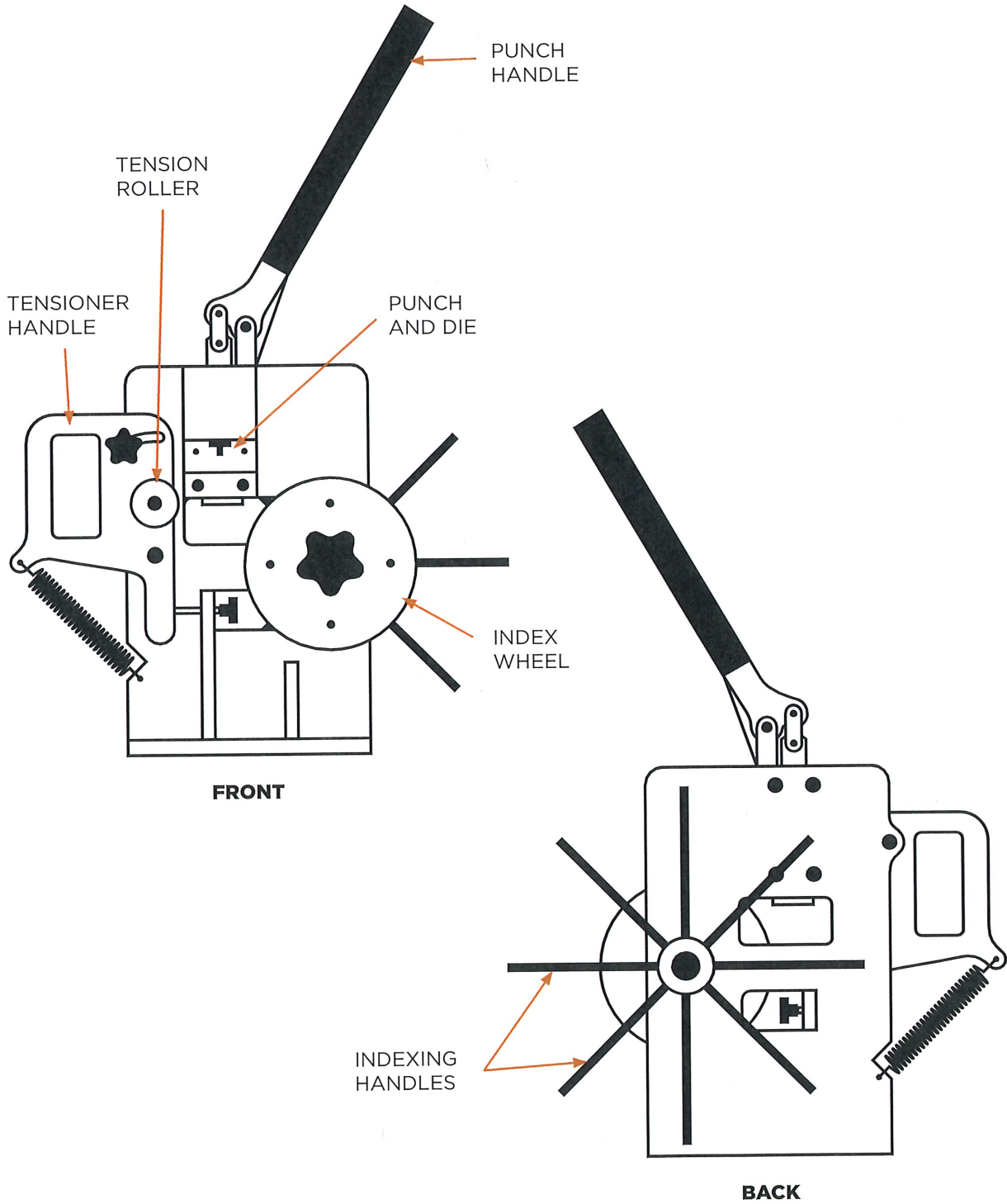

## 2.0 SETTING UP FOR USE

### 2.1 FITTING THE DISCS

The Stanhay Belt Punch comes complete with two wheels and 5 discs.

The larger of the wheels has three discs (image 1) while the smaller has two (image 2).

The discs are numbered with 1,2 and 3 matching the large wheel and 4 and 5 the smaller wheel.

Using the table on page 7 select the disc (and therefore wheel) required.

Fit the disc to the wheel (image 3).

Fit the wheel to the machine (image 4). Slide the wheel onto the shaft and then tighten the retaining knob.

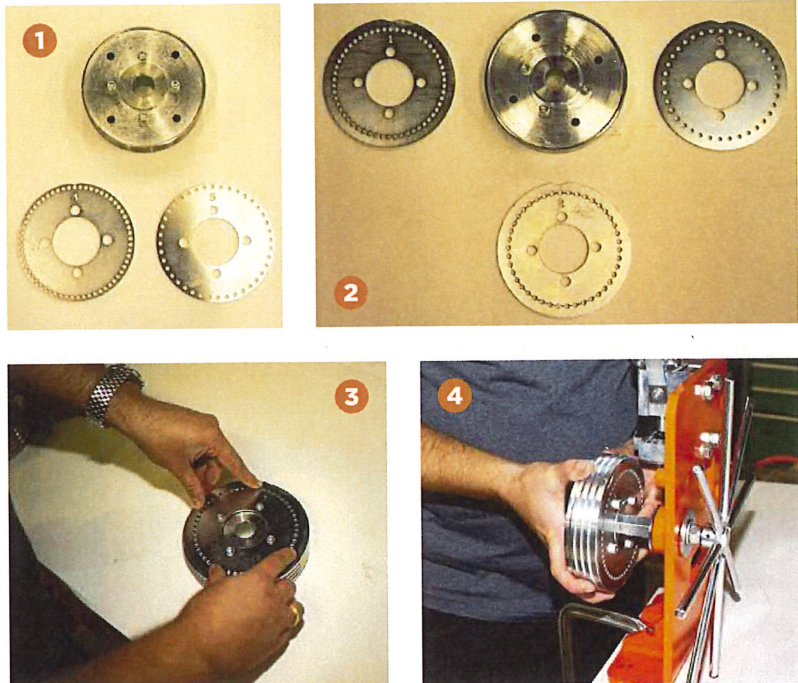

### 2.2 FITTING THE PUNCH AND DIE TO THE MACHINE

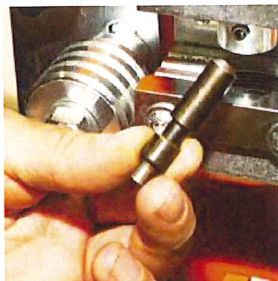

PUNCH



PUNCH FITTING



DIE

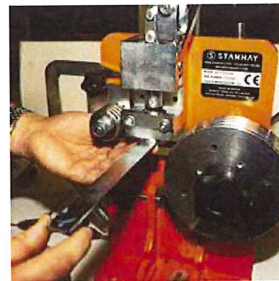

DIE FITTING



COMPLETE MACHINE READY FOR BELT

## 2.0 SETTING UP FOR USE

### 2.3 FITTING THE BELT

Fit the belt to the machine (image 1). Push the tensioner handle to allow the belt to be fitted.

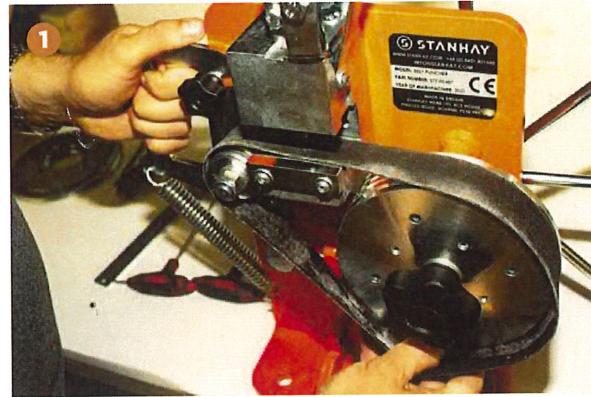

### 2.4 SETTING THE BELT TENSION

Mark the belt in line with the edge of the plate (image 2).

Turn the belt using the indexing wheel one complete revolution and ensure that the mark lines up with the edge of the plate (image 3). If it does not, then adjust the belt tension. The tension is adjusted using the tensioning roller.

Once the adjustment has been made realign the mark on the belt with the edge of the plate and complete another revolution as before (image 4).

Once the correct tension has been achieved ensure the lever is locked off (image 5). The stop can then be set to ensure a consistent tension (image 6).

**Once this procedure is complete the machine is ready to punch.**

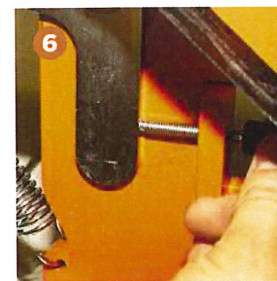
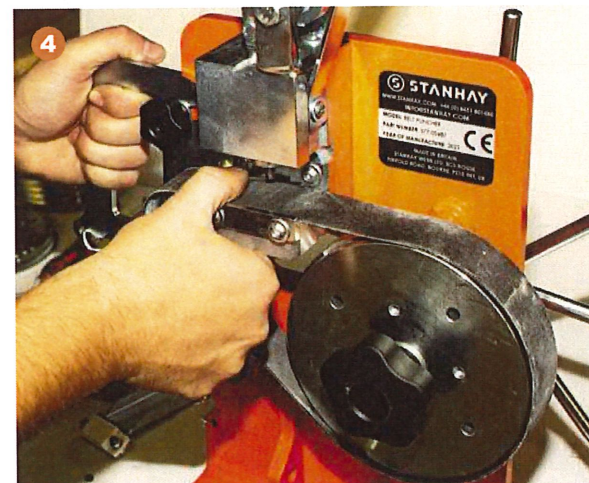
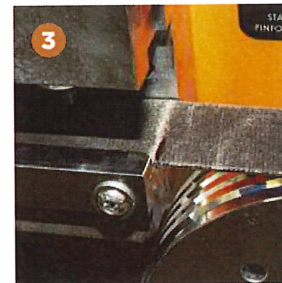

## 3.0 PUNCHING WITH THE MACHINE

### 3.1 PUNCHING METHOD

Using the table from page 7 select the punching method. This will inform you how the belt is punched and how to index using the wheel.

**Before punching fit the waste material chute (image 1) which is magnetically attached as shown (image 2).**

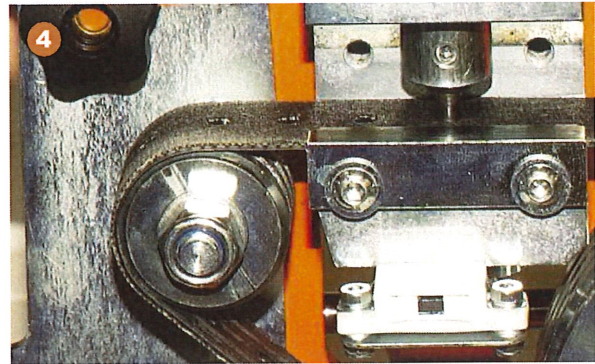
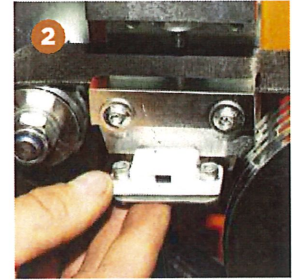

### 3.2 PUNCHED BELT

As seen in image 5 the holes have small fibres protruding.

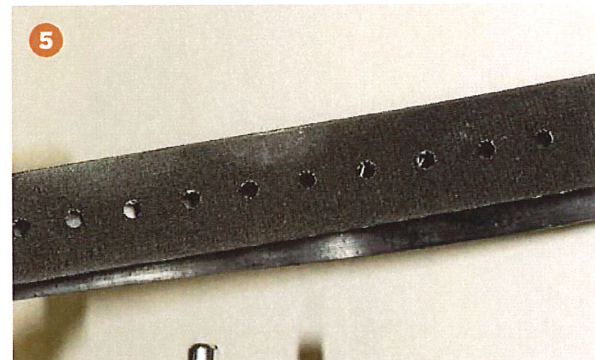

### 3.3 FINISHING THE BELT

In order to finish the belt, it should be flashed in front of a flame i.e. a blowlamp (image 6). This will remove any protruding fibers. This must be done quickly to avoid burning the belt and always wear flame retardant gloves. Green plastic belts do not require this final procedure.



## 3.0 PUNCHING WITH THE MACHINE

### 3.4 TWO LINE PUNCHING

The machine comes fitted with a guide plates to suit single line belts. For two line punching a second set of guide plates is available to enable two line punching (images 1 & 2).

#### Fitting the two-line guides

Single line guides and two-line guide are removed and fitted with four allen bolts as shown in images 3 & 4.

Once fitted the two-line guides move the belt offset from the centre to enable two line punching. The rest of the procedure is identical to punching a single line belt.

Once one line is completed the belt is removed and turned around. The second line is then punched (image 5).

For three line punching complete the above process and then revert to the single line procedure for the third (centre) line.

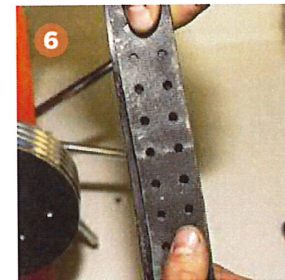
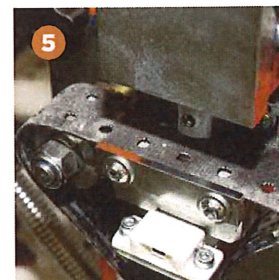
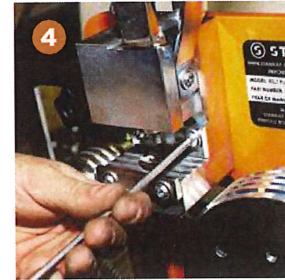
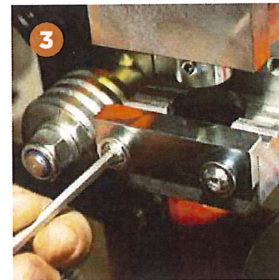
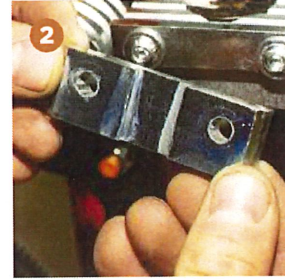
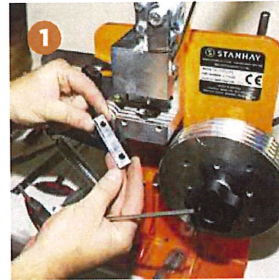



## 3.0 PUNCHING WITH THE MACHINE

### 3.5 PUNCHING METHOD TABLE

NO OF HOLES	DRUM DISC	METHOD
180	4	Punch 90 holes and then a further 90 holes between
144	1	Punch 72 holes and then a further 72 holes between
120	5	Punch 60 holes and then a further 60 holes between
112	2	Punch 56 holes and then a further 56 holes between
96	3	Punch 48 holes and then a further 48 holes between
90	4	Punch every hole
72	1	Punch every hole
60	5	Punch every hole
56	2	Punch every hole
48	3	Punch every hole
45	4	Punch 1,miss 1
40	5	Punch 20 holes and then a further 20 holes between
36	1	Punch 1, miss 1
32	1	Punch as for 16 holes and the a further 16 holes between
30	5	Punch 1 miss 1
	4	Punch 1 miss 2
28	2	Punch 1 miss 1
24	1	Punch 1 miss 2
	3	Punch 1 miss 1
20	5	Punch 1 miss 2
18	1	Punch 1 miss 3
	4	Punch 1 miss 4
16	3	Punch 1 miss 2
15	4	Punch 1 miss 5
	5	Punch 1 miss 3
14	2	Punch 1 miss 3
12	1	Punch 1 miss 5
	3	Punch 1 miss 3
	5	Punch 1 miss 4
10	4	Punch 1 miss 8
	5	Punch 1 miss 5
	6	Punch 1 miss 7
9	1	Punch 1 miss 7
	4	Punch 1 miss 9

Continued overleaf...

## 3.0 PUNCHING WITH THE MACHINE

### 3.5 PUNCHING METHOD TABLE (CONTINUED)

NO OF HOLES	DRUM DISC	METHOD
8	1	Punch 1 miss 8
	2	Punch 1 miss 6
	3	Punch 1 miss 5
6	1	Punch 1 miss 11
	3	Punch 1 miss 7
	4	Punch 1 miss 14
	5	Punch 1 miss 9
5	4	Punch 1 miss 17
	5	Punch 1 miss 11
4	1	Punch 1 miss 17
	2	Punch 1 miss 13
	3	Punch 1 miss 11
	5	Punch 1 miss 14
3	3	Punch 1 miss 15
	5	Punch 1 miss 19

### 3.6 PUNCH AND DIE SIZES

TYPE OF DIE	STANHAY PUNCH NUMBER	SIZE IN MM
PLAIN	4	1.58
	4.5	1.78
	5	1.80
	6	2.18
	6.5	2.38
	7	2.58
	7.5	2.78
	8	2.95
	8.5	3.18
	9	3.26

## 3.0 PUNCHING WITH THE MACHINE

### 3.6 PUNCH AND DIE SIZES (CONTINUED)

TYPE OF DIE	STANHAY PUNCH NUMBER	SIZE IN MM	
PLAIN AND 3 GROOVE	9.5	3.66	
	10	3.97	
	10.5	4.17	
	11	4.37	
	11.5	4.56	
	12	4.76	
	12.5	4.98	
	13	5.16	
	13.5	5.36	
	14	5.55	
	14.5	5.75	
	15	5.95	
	15.5	6.15	
	16	6.35	
	17	6.75	
	PLAIN AND 1 GROOVE	18	7.14
		19	7.54
20		7.94	
21		8.33	
22		8.73	
23		9.13	
24		9.52	
26		10.32	
28		11.11	
30		11.90	
32		12.70	
34		13.50	
36		14.29	
38	15.07		
40	15.87		
42	16.66		
44	17.46		
49	19.44		

The one groove and 3 groove dies are for 1 rib and 3 rib belts, these are used for larger seed sizes. Once the grooved die is fitted the punching method is exactly the same as described in this manual. Refer to the drill operators manual for further information.



STANHAY WEBB LTD  
BCS HOUSE  
PINFOLD ROAD  
BOURNE  
PE10 9HT  
UK

[WWW.STANHAY.COM](http://WWW.STANHAY.COM)

S66-00018

VERSION 1.2 OCTOBER 2021

Place dealer address here: