

OPERATING INSTRUCTIONS

(English) (cod.2032 02/99)

1. GENERAL INFORMATION AND CODING DATA

1.1. Manufacturer

• **FALC S.r.l.**

- via Proventa n.41 FAENZA (RAVENNA) ITALY
- ☎ ++39 0546 29050
- fax ++39 0546 663986
- e-mail: info@falc1960.com
- http: www.falc1960.com

1.2. **C.E.**

1.3. Series:

- PANDA DIGGING MACHINE
- MINI TORO DIGGING MACHINE
- TORO DIGGING MACHINE
- LEOPARD DIGGING MACHINE
- BUFALO DIGGING MACHINE
- DRAGO DIGGING MACHINE

1.4. INSTRUCTIONS ATTACHED TO THE MODELS

1.5. SERIAL NUMBER:

N.B.:

- THIS INSTRUCTION MANUAL MUST BE SUPPLIED WITH EACH UNIT OF THE ABOVEMENTIONED SERIES.
- THE MACHINE OPERATOR IS OBLIGED TO READ IT IN ALL ITS PARTS IN ORDER TO UNDERSTAND THE MACHINE'S CORRECT OPERATION.
- **SAFETY NOTES AND NOTES OF PARTICULAR IMPORTANCE ARE HIGHLIGHTED IN BOLD**

2. CONDITIONS OF USE

FALC digging machines are built to be coupled to an ideal tractor provided with a 3-point hitch and a Cardan shaft transmission. The digging machines, in their various series, are ideal in vegetable cultivation, greenhouses, nurseries, olive groves, vineyards and in great extensions. The work carried out by the digging machine is identical to the work of the old hand digging: penetration, pulling up, tossing. The digging machine does not cause the formation of the crushed, smooth, impermeable layer, left by the plough at the bottom of the furrow; on the contrary, it leaves the ground soft and permeable. The soil fertility is improved by the digging machine because the chemical or organic fertiliser is better blended in its entirety with the ground because it fosters the decomposition of the remains after harvesting, it improves the life of micro-organisms, indispensable for the transformation of organic matter. The digging machine is the only implement that allows the ground to be worked when it is wet or even if its surface is still covered with water. It is equally ideal in dry and hard soils as it allows the formation of limited sods, very much smaller than those that digging can leave, thus facilitating the subsequent refining operations for the preparation of sowing.

Every other use of the digging machines is to be considered illegal and prohibited by the manufacturer.

To prevent toppling risks, the tractor to be linked to the digging machine must be chosen taking into account the weight of the apparatus (kg) and of the distance of the centre line of the pins from the 3rd point from the centre of gravity of the digging machine itself (Xg) (see point 4.3.2.). The tractors must moreover be chosen with a power to suit the digging machine's size. The tractor's power values recommended by FALC are the following:

	hp	kw
Panda	20-35	15-26
Mini Toro	30-60	22-45
Toro	40-90	30-67
Leopard	80-180	59-133
Bufalo	100-180	74-133
Drago	100-240	74-177

IT IS ABSOLUTELY FORBIDDEN TO ALLOW PERSONS, ANIMALS OR THINGS TO CLIMB OR BE TRANSPORTED ON THE DIGGING MACHINES OF THE PANDA, MINI TORO, TORO, LEOPARD, BUFALO AND DRAGO SERIES.

2.1. USED IN FRONT OF TRACTOR

The Leopard, Bufalo and Drago series digging machines can be supplied with predisposal for connection to the front of the tractor on request. The operations necessary to connect and disconnect the digging machine from the 3-point front hitch are listed in paragraph 4.1 of this instruction manual.

ATTENTION: always check that the rotation direction of the tractor's front power take-off corresponds with the rotation direction of the gearbox.

3. CONDITIONS FOR THE OPERATOR

- 3.1. During use of the digging machine, the operator must remain on the tractor in the driver's position. **The operator cannot leave the driver's position on the tractor if he hasn't disengaged the power take-off of the tractor itself.**
- 3.2. In normal conditions, that is, with the rear lid closed, the operator must ensure that when starting up the digging machine and during its operation, there are no persons within a radius of 5 m around the machine. **The operator must immediately stop the tractor as well as the digging machine if one or more persons enter within a 5 m radius around the machine.**

ATTENTION: It is dangerous to get close to the digging machine in operation due to the possibility of contact with moving parts as well as the throwing up of ground and stones present in the immediate vicinity of the machine.

It is absolutely prohibited to climb onto a digging machine in movement.

4. INSTRUCTIONS TO CARRY OUT THE FOLLOWING OPERATIONS WITHOUT ANY RISK

4.1. SETTING UP THE DIGGING MACHINE

4.1.1. Connection of the Falc digging machine to the tractor

All Falc digging machines can be mounted onto any type of tractor provided it is supplied with a 3-point universal hitch. **During the connecting phase, the tractor must be positioned on level ground, with the engine off and the handbrake on. It is forbidden to all persons to stay on the tractor until the connection phase is fully carried out.** The following, are necessary precautions for a correct connection of the Falc digging machines to the tractor:

- a) **(fig.1)** Provide for the connection of the 3rd point of the digging machine with the tractor arms by means of the relative dowels. Block these with the split pins supplied.
- b) Adjust the tractor's 3rd point upper tierod until the digging machine takes up a configuration similar to that shown on fig. 1 when it rests on its skids or on its wheels, that is, with the 3-point hitch arms perpendicular to the ground **(fig.1 pos.A)**.
- c) Connect the tractor's power take-off and that of the digging machine's transmission box with the protected Cardan joint. Furthermore, ensure that the Cardan shaft has locked onto the 2 power take-offs.
- d) Climb onto the tractor and activate the hydraulic lift, verify that:
 - **(fig.2)** the moment the digging machine lowers itself, the female part **B** of the Cardan shaft does not strike the male part **A** and that the male part A does not strike the cross of the of the clutch assembly **C**.
 - **(fig.3)** a minimum sliding margin of 4 cm always remains in the most distant position, that is, with the digging machine fully lifted.
- e) Adjust the skids or the wheels to achieve the desired working depth (see point 4.3).

- f) **ATTENTION:** For the standard series machines the maximum revolutions of the P.T.O. can be:
- 540 r.p.m. for the Panda, Mini Toro, Toro series.
 - 1000 r.p.m. for the Leopard, Bufalo, Drago series.

4.1.2. Disconnection of the digging machine from the tractor

During the disconnection phase, the tractor must be positioned on level ground with the engine off and the handbrake on. It is forbidden to all persons to stay on the tractor until the disconnection operation has been fully carried out. The following, are necessary precautions for a correct disconnection of the Falc digging machines from the tractor:

- a) Stop the tractor on level ground, activate the handbrake, turn the engine off and disconnect the power take-off.
- b) Adjust the height of the skids or of the wheels so that the digging machine, resting on the ground, is in a horizontal position (see point 4.3).
- c) Ease the digging machine on the ground activating the tractor's hydraulic lift.
- d) Disconnect the Cardan joint from the tractor's power take-off and place it in the appropriate support.
- e) Loosen the tractor's 3rd point's upper tierod until the digging machine, by inclining itself rests on the spades.
- f) Disconnect the digging machine from the 3-point hitch of the tractor first by sliding out the split pins that block the dowels and then by removing the pins themselves.
- g) Climb onto the tractor again and move it forward to completely free the tractor's arms from the 3rd point of the digging machine.

4.2. USING THE DIGGING MACHINE

4.2.1. After having correctly connected the digging machine to the tractor, the operator can start working, remembering to respect the conditions mentioned in point 3.

4.2.2. In order to start the digging work correctly and not have problems further on, the operations to carry out are the following:

- a) Get to the working area with the digging machine lifted by the tractor's hydraulic arms.
- b) Stop the tractor, lower the digging machine until the spades skim the ground.
- c) Engage the power take-off in such a way that the spades carry out their stroke without penetrating into the ground.
- d) Slowly lower the digging machine to let the spades penetrate into the ground and at the same time, if necessary, increase the tractor's revolutions.
- e) When the digging machine is completely on the ground, that is, resting entirely on the skids or on the wheels, engage the gear and start working by gradually accelerating until obtaining the right running speed.
- f) **RUNNING SPEED:**
 - Very heavy soils \Rightarrow 1,50 - 1,60 km/h
 - Medium mix soil \Rightarrow 2,00 - 2,50 km/h
- g) At the end of the track, disconnect the power take-off before lifting the digging machine; the risk, is in fact that the Cardan shaft works at an excessive angle which could affect its proper operation and duration.

h) **WORKING ON A CURVE MUST ABSOLUTELY BE AVOIDED.** The spades and the spadeholder assemblies would undergo a lateral strain with possible damages of great entity.

4.2.3. The position of the rear lid or grid determines the good results of the work:

Dry soils: to achieve the best crushing of the soil and perfect levelling, the lid or the grid must be lowered and kept close to the spades.

Humid, wet or clayvevy soils: to prevent stalling, the lid and the grid must be raised and kept as far as possible from the spades.

The adjustment of the lid or of the grid, can only be carried out if the digging machine is stopped and the Cardan joint is not connected to the tractor's power take-off.

4.2.4. Use of the Cardan joint with clutch (or different safety sistem) for stony soils

In case of soils with rocks or stones or other materials that could collide with the spades, the use of Cardan joints with clutch or other safety systems, is indispensable. Besides this, it is recommended to keep the motor revolutions low so as to deaden the strikes as much as possible. **Inconveniences derived as a result of working on particularly stony soils or with protruding rocks will not be covered by the warranty.** The setting of the Cardan joint clutch must be checked as well to ensure that it effects its function correctly. It is recommended that this checking be carried out by a specialised service centre. The clutches of the Cardan shafts supplied by the company Falc, are set to the maximum load available. It is recommended that the Cardan shaft clutch be checked by a specialist every 300 working hours or, if the work is seasonal, at the beginning of activity after the resting period.

4.3. ADJUSTMENT OF THE WORKING DEPTH

4.3.1. Adjustment of the working height is achieved by lifting and lowering the position of the skids or of the wheels.

4.3.2. Inexpert users are advised to start working with the digging machine at a medium depth and only later exploit the entire working depth available.

4.3.3. (see **fig.1**) After having adjusted the digging machine to the desired working depth, it is essential to check that the spade, during its return stroke, (C → A) does not strike the soil yet to be worked with its lower part. In practice, the movement (C → A) of the spade, must take place above the soil that is still to be worked. In case of ground with ditches or humps, the working depth must be adjusted so as not to allow the above problem to repeat itself.

4.3.4. In order to change the position of the skids or of the wheels, carry out the following steps (see **fig.8**): (If the digging machine is connected to the tractor's 3rd point)

- a) Stop the tractor on level ground, activate the handbrake, turn the engine off and disconnect the power take-off.
- b) Lift the digging machine from the ground by using the tractor's hydraulic arms.
- c) Turn the tractor's engine off and leave the driver's position.
- d) Disconnect the Cardan joint from the tractor's power take-off.

e) **ATTENTION: It is absolutely prohibited to anyone to stay on the tractor's driver's position while carrying out the adjustment of the skids or of the wheels.**

f) Slide out the split pins and the dowels that block the skids or the wheels.

g) Locate the skids or the wheels in the desired position and block them with the relative dowels and split pins.

h) Climb onto the tractor again and lean the digging machine on the ground to verify that the new position is correct.

If the digging machine is not connected to the tractor's 3rd point, adequate equipment must be utilised to lift it from the ground (the digging machines' weights are reported in point 4.2.2 of this instruction manual).

4.4 TRANSPORT

4.4.1. During operation, the digging machines rest on the tractor's 3rd point and on the skids or wheels, depending on the model.

4.4.2. For machine transport in non-operational conditions, the digging machines are completely carried by the tractor. Dimension (X_g) represents the distance of the machine's centre of gravity from the centre line of the pins of the 3rd point. The weights are the following:

	Peso (kg)	X_g (mm)
Panda 1000	225	340
Panda 1300	310	340
Mini Toro 1000	340	530
Mini Toro 1300	440	530
Mini Toro 1500	470	530
Mini Toro 1700	490	530
Mini Toro 1800	590	530
Mini Toro 2000	610	530
Toro 1500	675	550
Toro 1700	710	550
Toro 1800	820	550
Toro 2000	880	550
Toro 2200	1080	550
Toro 2500	1120	550
Leopard 2700	1470	670
Leopard 3200	1720	670
Leopard 4200	2200	670
Bufalo 3100	2220	810
Bufalo 4200	2740	810
Drago 3100	2640	850
Drago 4200	3500	850

4.4.3. When it is necessary to move the machine for loading, unloading or storage purposes, always make use of equipment suitable for the machine weight (see 4.4.2.).

4.5. ASSEMBLY AND DISMANTLING

As a result of the place taken up by the standard supply safety guarding during the transportation phase, it may become necessary to dismantle it. In this case, the guarding will be delivered separately from the machine and it will be the responsibility of the receiver to provide for their positioning. In order to correctly position the side guarding simply consult the spare parts table related to the specific type of digging machine. The guards are supplied complete of their fixing nuts and screws.

4.6. CHANGING THE SPEED OF THE GEARBOX

The gearboxes contain a spare set of gears within the same which can replace those mounted with the standard series.

ATTENTION: wait until the gearbox has cooled off before touching it. Cooling time is depends on the use which has been made of the digging machine before stopping the same and on the weather conditions.

ATTENTION: The manual replacement of the gears in the gearbox can only be carried out if the digging machine in not connected by means of the Cardan joint to the tractor's power take-off.

In order to replace the gears within the gearbox, the operations are as follows: (see **fig.9**)

- a) Stop the tractor with the connected digging machine on plane ground, activate the handbrake and disengage the power take-off.
- b) Climb off the tractor, disconnect the Cardan joint from the tractor's power take-off and place it in the appropriate support.
- c) **Wait until the gearbox has cooled off before touching it. Cooling time is depends on the use which has been made of the digging machine before stopping the same and on the weather conditions.**
- d) **After having ensured that the gearbox is cool**, unscrew the discharge plug (**fig.9 pos.27**) and collect the oil which will flow out of it, in a suitable container.
- e) **ATTENTION:** do not discard this oil in the natural environment.
- f) Unscrew the bolts **pos.23**, remove the lid **pos.22** taking care not to damage the gasket **pos.21**.
- g) Replace the gears **pos.35-37** with the spare ones **pos.36-38** strictly adhering to the diagram shown on the label located on each digging machine Take extreme care in reassembling the elastic rings and the split pins **pos.40-41**.
- h) Reassemble the lid and the relative gasket, place the screws and position the discharge plug **pos.27**.
- i) Fill with the previously discharged oil through the oil cap **pos.11** and check its level with the plug **pos.10**.

4.7. MAINTENANCE AND REPAIRS

Before approaching the machine to carry out any maintenance or repairs, it is compulsory to take some precautions:

- a) Stop the tractor on level ground, activate the handbrake, turn the engine off and disengage the power take-off.
- b) Disconnect the digging machine from tractor's the 3-point hitch (see paragraph 4.1.2.). After having carried out these operations the operator can approach the digging machine in order to carry out maintenance and repairs.

IT IS ABSOLUTELY FORBIDDEN TO CARRY OUT MAINTETANCE AND REPAIR OPERATIONS IF THE DIGGING MACHINE IS CONNECTED TO THE TRACTOR.

In case of specific maintenance or repair where it is necessary to lift the machine from the ground or topple it, it is indispensable to use suitable equipment built for such purposes. It is always recommended to consult the area sales assistance or mechanical workshops ideally equipped.

The machines' weights are reported in point 4.4.2. of this instruction manual.

4.7.1. Assembly and dismantling of the spades

The replacement of the spades can only be carried out if the digging machine is lifted from the ground by means of suitable equipment built for such purposes. It is hence forbidden to replace the spades if the machine is connected to the tractor's 3rd point.

The moment changing of the spades takes place, it is recommended to pay utmost attention to the following:

- Panda-Mini Toro-Toro Leopard models: install the spades with the mark (F) facing towards the rear lid.
- Bufalo-Drago models: install the spade with the chamfered cutting part facing the rear lid.
- in order to have a perfect ground penetration angle of the tool, it is recommended that only original Falc spades be used.

4.7.2. Assembly and dismantling of the spadeholder arms near the gearbox

The spadeholder arms can be assembled and dismantled only if the digging machine is lifted from the ground by means of suitable equipment built for such purposes. It is hence forbidden to assemble and dismantle the spadeholder arms if the machine is connected to the tractor's 3rd point.

To dismantle the spadeholder assembly, near the gearbox (right side looking at the machine from the P.T.O.), carry out the following operations:

- a) Release the spadeholder arm from the frame's lower pipe by unscrewing the bolts **fig.6 pos.D**.
- b) (see **fig.7**) Bring the crank (**A**) in correspondence of the gearbox's recess (**B**) (Recess **B** is oversized in comparison with the box's other recesses).
- c) Remove the screw (**C**) from the recess (**B**) (Such screw does not exist on the Panda model).
- d) Remove the nut from pin (**D**) and strike the same pin inside the recess (**B**) until the pin's head (**D**) rests on the gearbox.
- e) Move the arm (**E**) and free it from the coupling with the spadeholder arm.
- f) **ATTENTION: fix the spadeholder arm with a hoist or similar suitable apparatus to prevent that as soon as freed from the pin, it falls dangerously on the ground.**
- g) Slide the spadeholder arm from the pin (**D**).

4.7.3. Maintenance

Granted that all the digging machines are delivered well greased and lubricated, hereafter is a list of rules which must strictly be adhered to, so as to obtain the best results.

a) **Gearbox oil** (Mobil Gear 634 - SAE 140)

- Check the level every 8 working hours and tip up if necessary.
- Change the oil every 300 working hours.
- **ATTENTION: wait until the gearbox has cooled off before touching it. Cooling time is depends on the use which has been made of the digging machine before stopping the same and on the weather conditions.**
- **ATTENTION: the used oil must not be discharged into the natural environment, but consigned to bodies authorised for collection and subsequent disposal.**

b) **Tightening of screws**

- Check that all bolts and screws are correctly tightened after the first hour of operation and subsequently every 30-40 hours of work.

c) **Panda model: Joints lubrication** (see fig.4)

- In the Panda model the joints A-B-C are on protected life lubricated sealed bearings, therefore no lubrication is necessary.

d) **Mini-Toro - Toro model: Joints lubrication** (see fig.4)

- Grease all "A" assemblies every 50 working hours
 - Grease all "B" assemblies every 50 working hours. Attention: in case of overheating of the "B" assembling, due to an excessive quantity of grease, leave the grease fitting off, let the digging machine turn for 5 minutes and refit the grease fittings. In this way you have eliminated the grease in excess.
 - Grease all "C" assemblies every 15-20 working hours.
- Attention: add the grease slowly; do not fill the support completely. Too much grease can cause an overheating.

e) **Leopard - Bufalo model: Joints lubrication** (see fig.4)

"A" assembling: lubrication with grease

grease all "A" assemblings every 50 working hours

Attention: add the grease slowly; do not fill the support completely. Too much grease can cause an overheating

"B-C" assemblings: lubrication with oil

- All mechanical movements run on oil bath bearings with F:P:S: protection (FALC PROTECTION SYSTEM).

- Oil utilised: Mobil Gear 634 - SAE 140.

- "B-C" Assembly: check the oil level every 50 working hours; be sure that the oil level covers about half of the axle. Add oil if necessary.

f) **Drago model: Joints lubrication** (see fig.6)

- All mechanical movements run on oil bath bearings with F:P:S: protection (FALC PROTECTION SYSTEM).

- Oil utilised: Mobil Gear 634 - SAE 140.

- Assembly "A": check the oil level every 50 working hours. To facilitate the oil topping up operation, remove the two threaded dowels (pos. A1) so as to allow the air within to escape thus not create any pressure. The upper cap is to add oil, the lower cap is to check the oil level.
- Assembly "B-C": check the oil level every 50 working hours; be sure that the oil level covers about half of the axle. Add oil if necessary.

g) **Cardan joint**

- Lubricate the Cardan joint every 8 working hours (see the specific Instruction manual relative to the Cardan joint).
- **ATTENTION: the Cardan joint is in general supplied by FALC and is suitable for the effective power required for the tractor-shredder link-up. In case of replacement always use a Cardan joint with characteristics not inferior to those of the original Cardan shaft.**

- h) Prior to a period of inactivity, it is recommended to accurately clean the machine from remains accumulated during operation. During the period of inactivity, it is recommended to protect it from atmospheric agents.

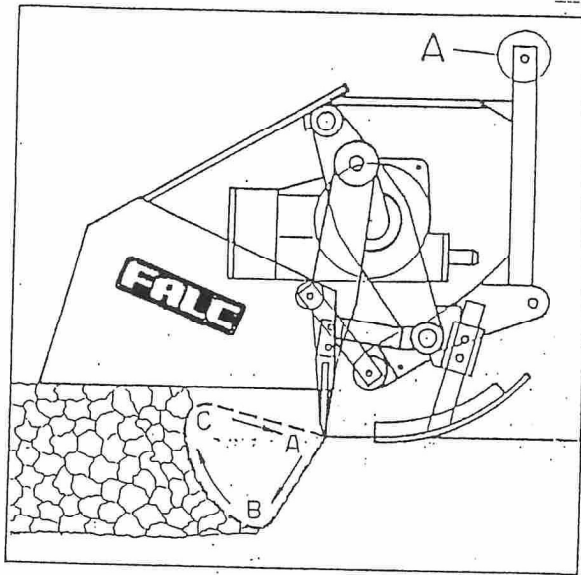

FIG. 1

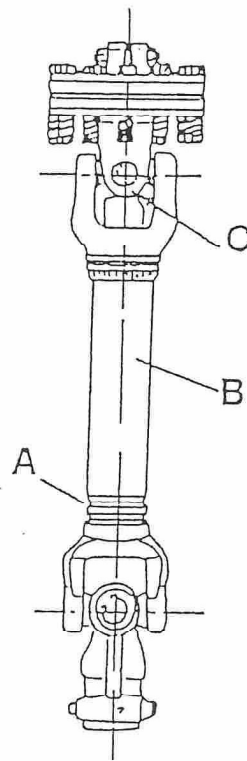

FIG. 2

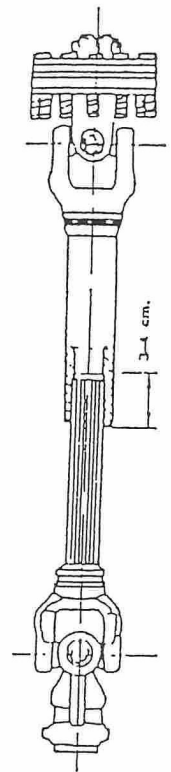

FIG. 3

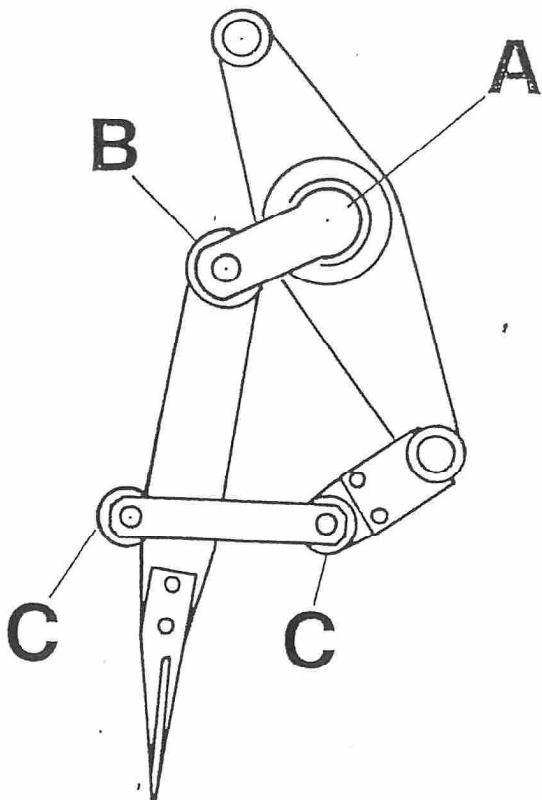

FIG. 4

FIG. 9

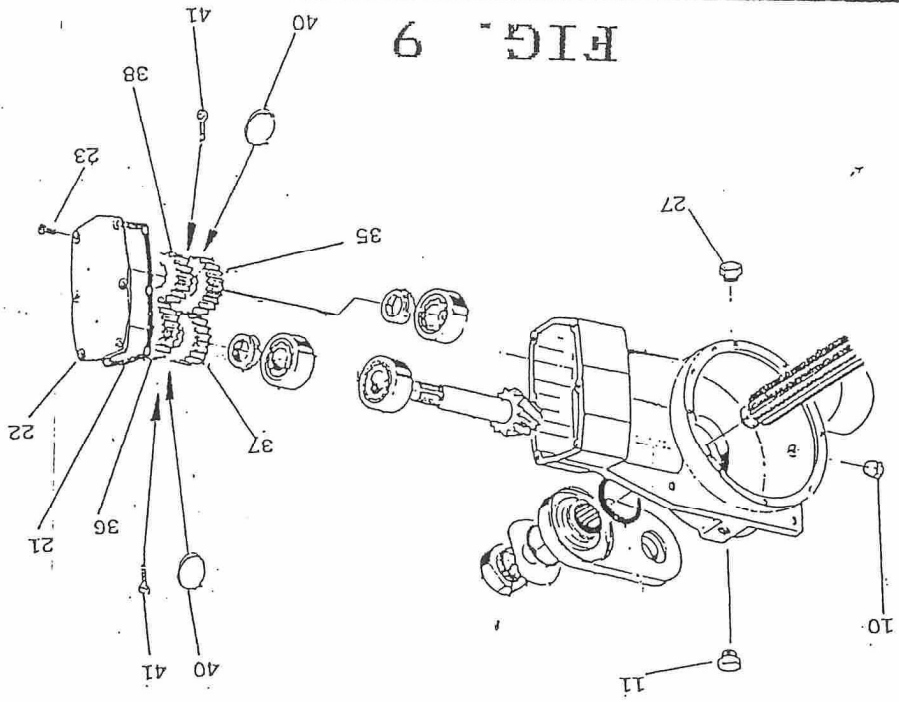

FIG. 8

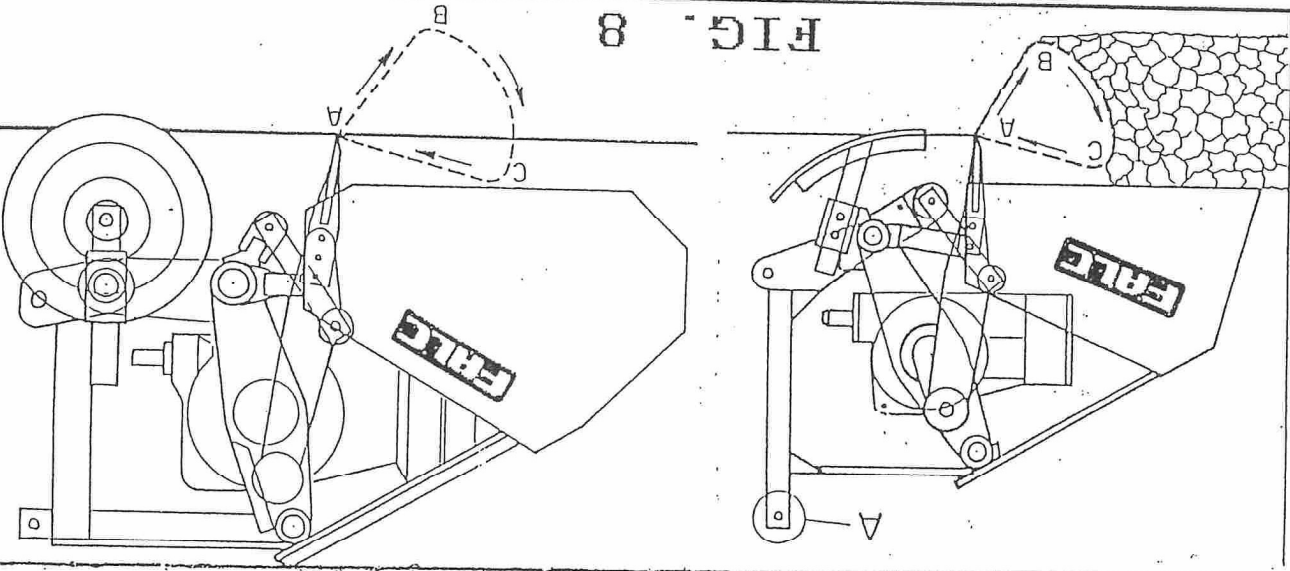

FIG. 6

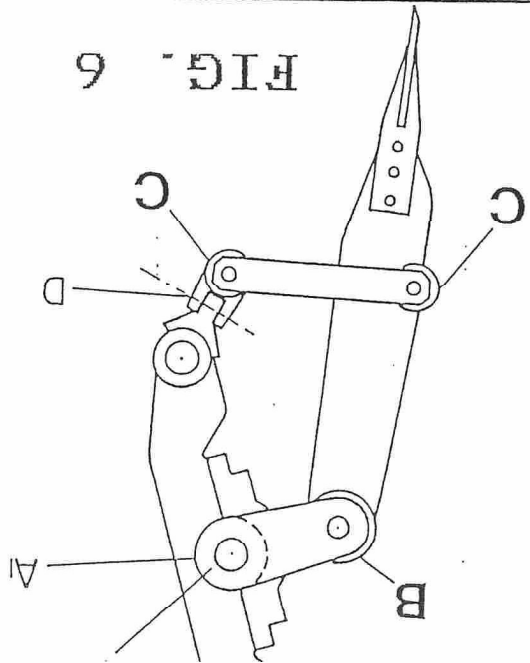
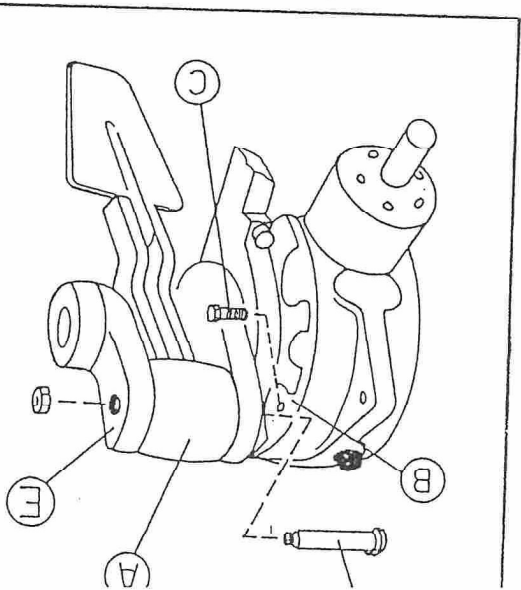

FIG. 7



5. WARRANTY

- 5.1. Warranty period is fixed at 6 months from delivery. The company commits itself to replace parts which might present material or construction defects, in the least time possible. Labour time necessary for the replacement is excluded from the warranty. Transport and/or dispatch expenses are also excluded from the warranty.
- 5.2. The buyer loses the warranty right if the faults are derived from force majeure, from an incorrect use of the machine or from any wrong action on behalf of the buyer, his employees or third parties. Repairs, replacements and modifications carried out or made to carry out by the buyer without the manufacturing company's authorisation are included among these actions. An incorrect use of the machine is the result of absence of adherence to the operating instructions listed in this manual.
- 5.3 Parts which due to their nature or function are subject to inevitable wear and tear or strain, are excluded from the warranty.
- 5.4 Bearings and oil seals are excluded from the warranty.
- 5.5 The Cardan shaft is excluded from the warranty
- 5.6 The following rules are applicable to the parts for which warranty is intended:
- a) the part to be replaced must be returned to the company on request of the new part.
 - b) the spare parts will always be invoiced on dispatch.
 - c) only the examination of the part on behalf of the manufacturing company's technicians could give the right to recognition of the warranty and hence a right to the credit.

6. RULES TO OBSERVE IN ORDERING SPARE PARTS CORRECTLY

To obtain a speedy dispatch of spare parts orders, it is necessary to specify:

- a) Machine type, Model, Serial Number.
(e.g. DIGGING MASCHINE DRAGO 3100 S.N. XXXXX)
- b) Spare parts table number where the part in question is located, Identification Number, Part code.
(e.g. Table no. YY, Detail no. JJ, Code KKKKKK)
- c) Exact name of the detail.
- d) Quantity of pieces requested.
- e) Dispatch instructions.
(by rail, parcel post, courier, etc.)
- f) **The minimum delivery time of the requested parts is 3 days from receipt of order**

7) SAFETY PICTOGRAMS

All the safety pictograms applied to Falc's machines, are based on norms ISO 11/684.

The adhesive labels adopted are 168 x 88 mm and are divided in two equal parts.

The left part contains within the triangular danger symbol the graphic description of the symbol itself.

e.g. Attention - Danger of flying objects.

The right part shows how to avoid the risk.

e.g. Maintain a safety distance.

Together, these 2 graphics synthesise the full message which is intended to be transmitted to all those which for various reasons are in direct contact or nearby a Falc-produced machine.

(see enclosure C of the norm)

The graphical message is hence directed to the machine operators as well as all those that enter within the working radius of the machine.

The operator is obliged to carefully read the machine's instruction manual in order to understand its correct operation and to have a comprehensive explanation of the safety pictograms

The complete list of all the pictograms which are applied to Falc-produced machines is reported hereafter with the relative explanation on the side.

Label no.1

ATTENTION : Read the instruction manual before using the machine.

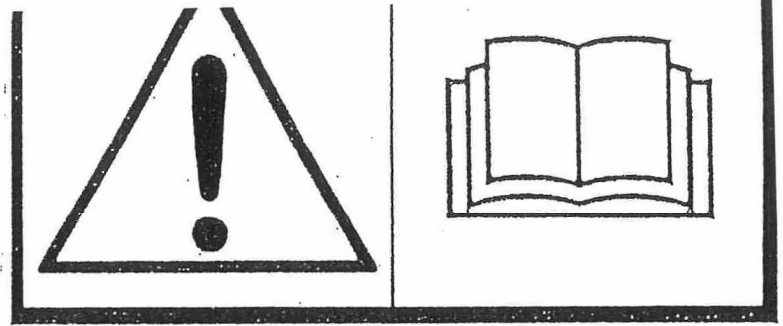

Label no.2

ATTENTION : Danger of hand and fingers collision with movements in alternate rotation.

Keep the safety distance.

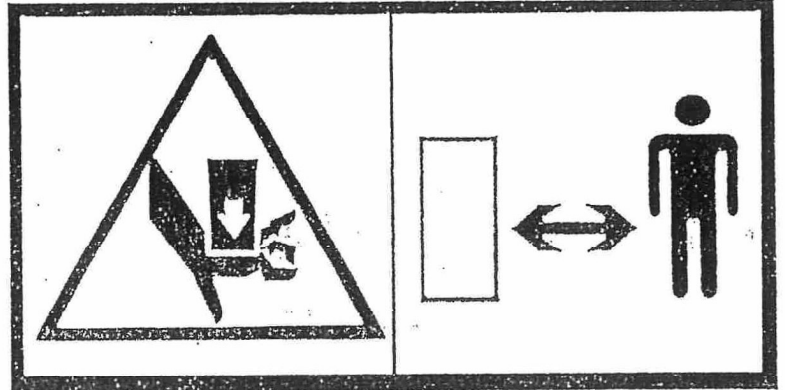

Label no.3

ATTENTION : Danger of foot collision with movements in alternate rotation.

Keep the safety distance.

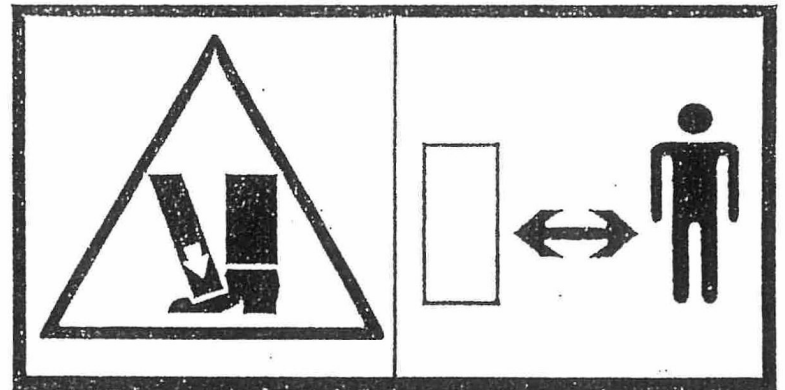

Label no.4

ATTENTION : Danger for feet due to rotating cutters with horizontal rotating axis.

Keep the safety distance.

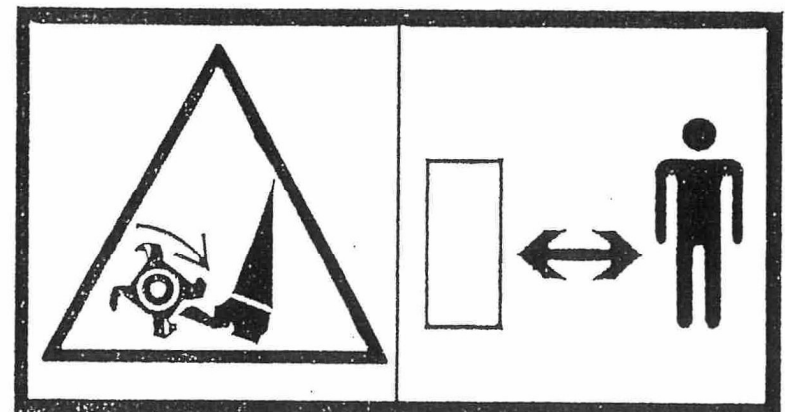

Label no.5

ATTENTION : Danger due to machine component that can be lifted from the ground.

Keep the safety distance.

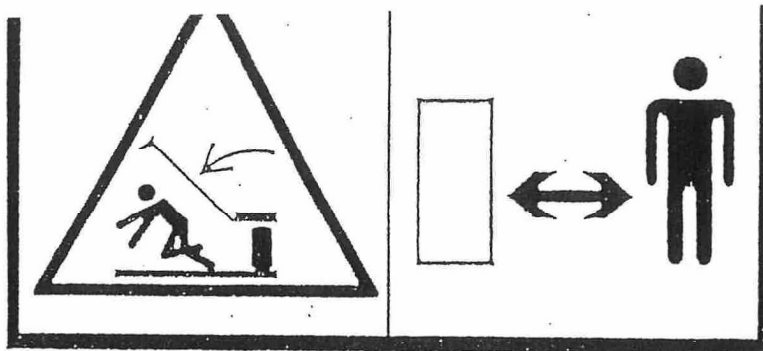

Label no.6

ATTENTION : Danger of cutting due to moving parts.

Wait until all moving components are completely still before approaching the machine.

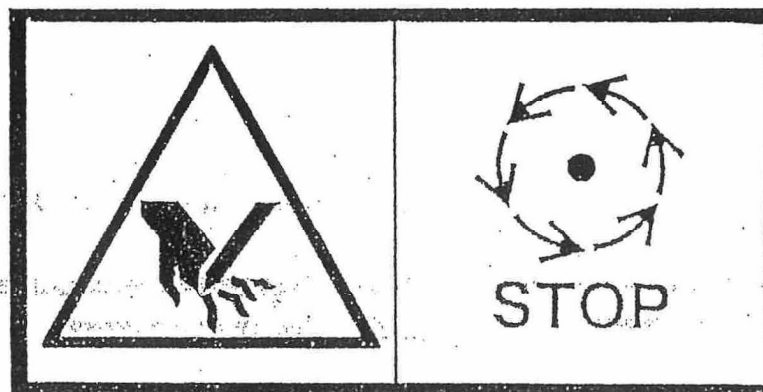

Label no.7

ATTENTION : Danger due to flying objects.

Keep the safety distance.

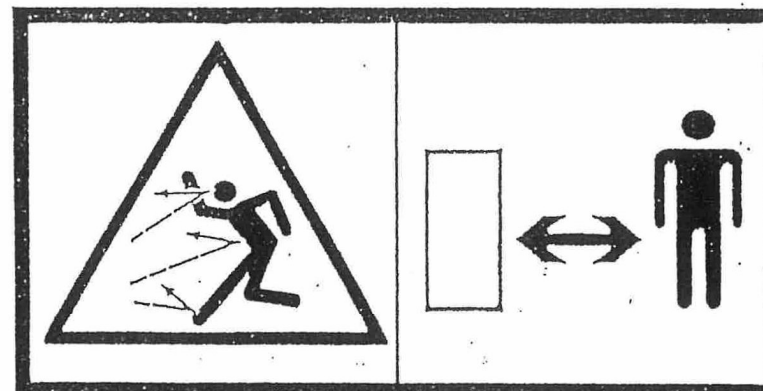

Label no.8

ATTENTION : Danger due to hot surfaces.

Keep the safety distance.

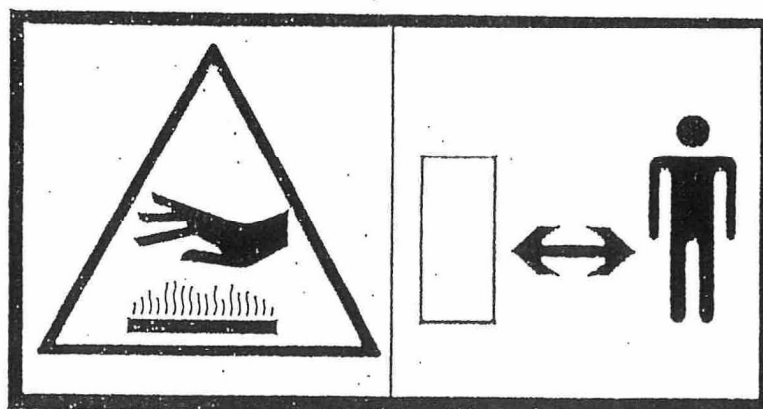

Label no.9
ATTENTION : Danger of hand and
 finger cutting.
 Keep the safety distance.

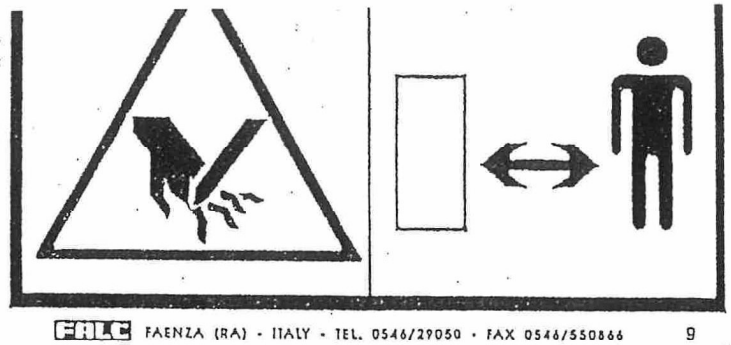

FRLC FAENZA (RA) - ITALY - TEL. 0546/29050 - FAX 0546/550866 9

Label no.10
ATTENTION : Danger of feet cutting.
 Maintain the safety distance.

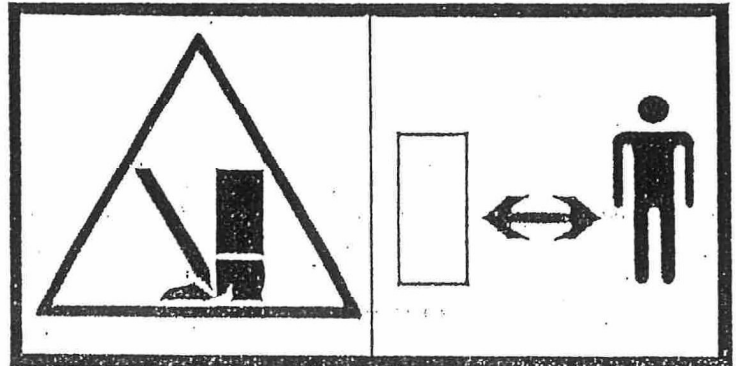

FRLC FAENZA (RA) - ITALY - TEL. 0546/29050 - FAX 0546/550866 10

Label no.11
ATTENTION : Danger of rotating
 movements.
 Do not open or remove the safety guards
 of the rotating shafts while the machine is
 in operation.

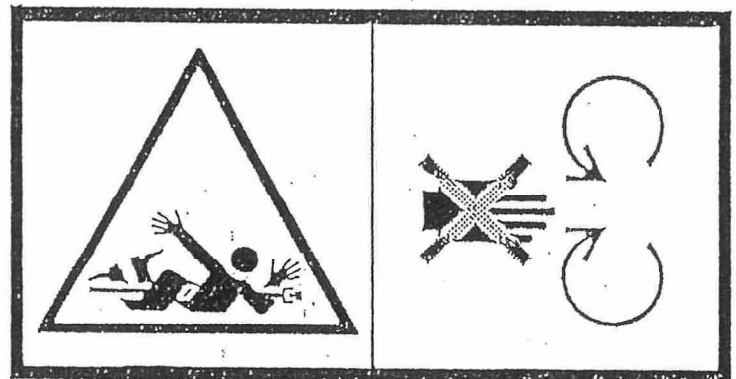

FRLC FAENZA (RA) - ITALY - TEL. 0546/29050 - FAX 0546/550866 11

Label no.12
ATTENTION : Danger due to loads
 lifted from the ground.
 Keep the safety distance.



FRLC FAENZA (RA) - ITALY
 TEL. 0546/29050 - FAX 550866 12

IF ANY PART OF THIS INSTRUCTION MANUAL SHOULD RESULT INSUFFICIENTLY CLEAR, WE ASK YOU TO KINDLY CONTACT YOUR CLOSEST AUTHORISED DEALER OR CONTACT US DIRECTLY AT OUR TECHNICAL AND COMMERCIAL DEPARTMENTS.

INDEX

1. General information
2. Conditions of use
 - 2.1. Used in front of tractor
3. Conditions for the operator
4. Instructions to carry out the following operations without any risk:
 - 4.1. Setting up the digging machine
 - 4.2. Using the digging machine
 - 4.3. Adjustment of the working depth
 - 4.4. Transport
 - 4.5. Assembly and dismantling
 - 4.6. Changing the speed of the gearbox
 - 4.7. Maintenance and repairs
5. Warranty
6. Rules to observe in ordering spare parts correctly
7. Safety pictograms

This handbook or any part of it cannot be reproduced, copied or published without prior written authorization of FALC.

FALC reserves the right to modify the here described specifications at any time without committing itself to update this handbook every time.

Italiano: Istruzione per il montaggio del cardano

<p>Prima di montare il cardano, leggere attentamente il Libretto fornito dal costruttore del cardano stesso.</p> <p>La Ditta Falc Srl declina ogni responsabilità per operazioni effettuate sul cardano senza seguire le Istruzioni specifiche fornite dal costruttore del cardano stesso.</p>	<p>Prima di iniziare a lavorare, si raccomanda di verificare la lunghezza del cardano:</p> <p>se è LUNGO, alzando o abbassando la macchina, le 2 parti telescopiche si accoppieranno completamente creando pressione sulle crociere e sulle forcelle; se è CORTO, alzando o abbassando la macchina, le 2 parti telescopiche si sfileranno troppo.</p>	<p>Le macchine agricole portate sono collegate direttamente al trattore e posizionate mediante attacco a tre punti. Generalmente con attrezzo in lavoro (a) si ha la configurazione di minore lunghezza dell'albero ed angoli di snodo sensibilmente uguali. Ad attrezzo sollevato (b) si ha la massima estensione dell'albero, l'aumento e la diversificazione degli angoli di snodo. Durante il sollevamento è INDISPENSABILE interrompere la rotazione del cardano.</p>
--	---	---

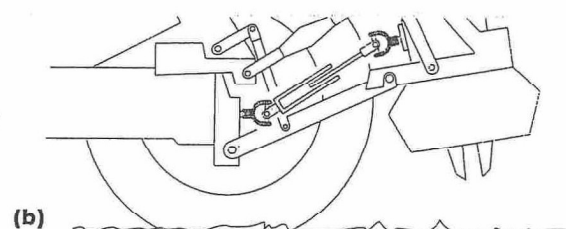
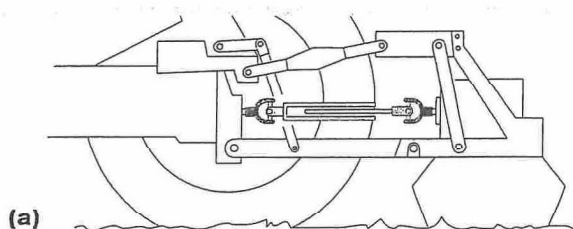

Français: Instructions pour le montage de l'arbre à cardan

<p>Avant de monter le cardan, lire attentivement le Livret fourni par le fabricant du cardan lui-même.</p> <p>L'entreprise Falc Srl décline toute responsabilité pour toute opération effectuée sur le cardan sans avoir suivi les instructions spécifiques fournies par le fabricant de ce cardan.</p>	<p>Avant de commencer à travailler, nous recommandons de vérifier la longueur du cardan :</p> <p>s'il est LONG, en relevant ou en baissant la machine, les deux parties télescopiques vont s'accoupler complètement en exerçant une pression sur les tourillons et les fourchettes ; s'il est COURT, en relevant ou en baissant la machine, les 2 parties télescopiques risquent de se désenfiler trop.</p>	<p>Les machines agricoles portées sont connectées directement au tracteur et mises en place par l'attelage à trois points.. Avec l'outil en fonction (a) la configuration du cardan est de longueur minimum et les angles d'articulation sont similaires. Lorsque l'outil est soulevé (b), l'extension du cardan est au maximum et on a l'augmentation et la diversification des angles d'articulation. Pendant le soulèvement il est INDISPENSABLE d'interrompre la rotation du cardan.</p>
---	---	---

English: Instructions for the assembling of the cardan shaft

<p>Before mounting the cardan shaft, carefully read the booklet supplied by the Manufacturer.</p> <p>Falc Srl declines all responsibility for operations carried out on the cardan shaft if the specific instructions supplied by the Manufacturer are not followed.</p>	<p>Before starting work, it is advised to check the length of the cardan shaft:</p> <p>if it is LONG, by raising or lowering the machine, the 2 telescopic parts will couple completely, creating pressure on the cross and on the forks;</p> <p>if it is SHORT, by raising or lowering the machine, the 2 telescopic parts will slide apart too much.</p>	<p>The agricultural machinery carried is connected directly to the tractor and positioned using a three-point attachment. Generally, when the equipment is functioning (a) the shorter length of the shaft with equal articulation angles is present. With the equipment raised (b) there is maximum extension of the shaft, increase and diversification of the articulation angles. During lifting it is INDISPENSABLE to interrupt rotation of the cardan shaft.</p>
--	--	--

Deutsch: Bedingungen für die Gelenkwellenanbau

<p>Bevor Sie die Kardanwelle montieren, ist das vom Hersteller der Kardanwelle gelieferte Handbuch aufmerksam durchzulesen.</p> <p>Falc Srl haftet nicht für an der Kardanwelle durchgeführte Arbeiten, bei denen die spezifischen Anweisungen des Herstellers der Kardanwelle nicht eingehalten wurden.</p>	<p>Vor dem Beginn der Arbeiten ist die Länge der Kardanwelle zu überprüfen.</p> <p>Falls die Kardanwelle LANG ist, kuppeln die beiden Teleskopteile bei Heben oder Senken vollständig ein und drücken auf das Gelenkkreuz und das Gabelgelenk.</p> <p>Falls die Kardanwelle KURZ ist, fahren die beiden Teleskopteile bei Heben oder Senken zu sehr aus.</p>	<p>Die Anbau-Landmaschinen werden direkt an den Traktor angeschlossen und mit einem Dreipunktanschluss positioniert.</p> <p>Im Allgemeinen sind im Fahrzustand der Maschine (a) die Welle kürzer und die Gelenkwinkel annähernd gleich. Bei gehobener Maschine (b) ist die Welle maximal ausgefahren; die Gelenkwinkel sind größer und unterscheiden sich voneinander. Während des Hubs MUSS die Rotation der Welle unterbrochen werden.</p>
--	--	--

Español: Instrucciones para el montaje de la cardan

<p>Antes de montar el cardan, leer detenidamente el Manual suministrado por el fabricante de éste.</p> <p>La empresa Falc Srl se exime de cualquier responsabilidad frente a operaciones que puedan efectuarse en el cardan sin cumplimiento de las instrucciones específicas dictadas por el fabricante del mismo.</p>	<p>Antes de iniciar a trabajar, se recomienda comprobar que la longitud del cardan sea la adecuada:</p> <p>Si es demasiado LARGO, al alzar o descender la máquina sus 2 partes telescópicas se acoplarán completamente, creando presión en las crucetas y en las horquillas.</p> <p>Si es demasiado CORTO, al alzar o descender la máquina sus 2 partes telescópicas se desenhebrarán excesivamente.</p>	<p>Las máquinas agrícolas traídas están directamente unidas al tractor por medio de un enganche de tres puntos. Generalmente, cuando el equipo está en posición de trabajo (a) se obtiene una configuración con una menor longitud del árbol y con ángulos de articulación muy parecidos. Con el equipo en posición alzada (b) se obtiene la extensión máxima del árbol, con un aumento de los ángulos de articulación, que ahora serán distintos entre sí. Durante la elevación es INDISPENSABLE interrumpir la rotación del cardan.</p>
---	--	---

Nederlands: Instructies voor montage van de aftakas

<p>Lees de door de fabrikant geleverde handleiding aandachtig door alvorens de aftakas te monteren.</p> <p>Falc Srl wijst elke aansprakelijkheid af als de betreffende specifieke montageaanwijzingen niet worden opgevolgd.</p>	<p>Controleer eerst de lengte van de aftakas alvorens met de montage-werkzaamheden te beginnen.</p> <p>Als de aftakas TE LANG is, schuiven de beide telescopische delen volledig in tijdens het heffen en dalen van het werktuig en wordt druk uitgeoefend op de kruiskoppeling en de vorken;</p> <p>Als de aftakas TE KORT is, schuiven de beide telescopische delen tijdens het heffen en dalen van het werktuig te veel uit elkaar.</p>	<p>Aanbouwmachines worden bevestigd aan de driepuntskoppeling van de tractor.</p> <p>In het algemeen geldt dat als het werktuig in bedrijf is (a) de korter is en de knikhoek gelijk. Met het werktuig in geheven positie (b) is de as maximaal uitgeschoven, en is de knikhoek groter en variabel. Als het werktuig wordt geheven MOET de aftakas worden uitgeschakeld.</p>
--	--	--

Dansk: Montage af kardanaksel

<p>Før montagen af kardanakslens påbegyndes, gennemlæses producentens brugervejledning grundigt.</p> <p>Falc Srl er fritaget for ethvert ansvar i forbindelse med arbejder foretaget på kardanakslens, hvis de givne retningslinier, som er specificeret af producenten, ikke er fulgt nøje.</p>	<p>Før arbejdet påbegyndes, anbefales det at kontrollere kardanakslens længde ved at hæve eller sænke redskabet.</p> <p>Hvis den er for LANG, resulterer det i, at de to kardan dele støder sammen, når redskabet er i sin yderposition, hvilket bevirker et ødelæggende tryk på kardankryds og transmissioner.</p> <p>Hvis den er for KORT, resulterer det i, at de to kardan dele kan glide fra hinanden, hvilket bevirker, at de ikke er i indgreb med hinanden.</p>	<p>Redskabet monteres direkte på traktorens 3-punktsophæng. Generelt gælder, at når redskabet er sænket (a), er kardanakslens i sin korteste position, og når redskabet er hævet (b), er kardanakslens i sin længste position. Når redskabet hæves, SKAL kardanakslens rotation afbrydes.</p>
--	---	---

