

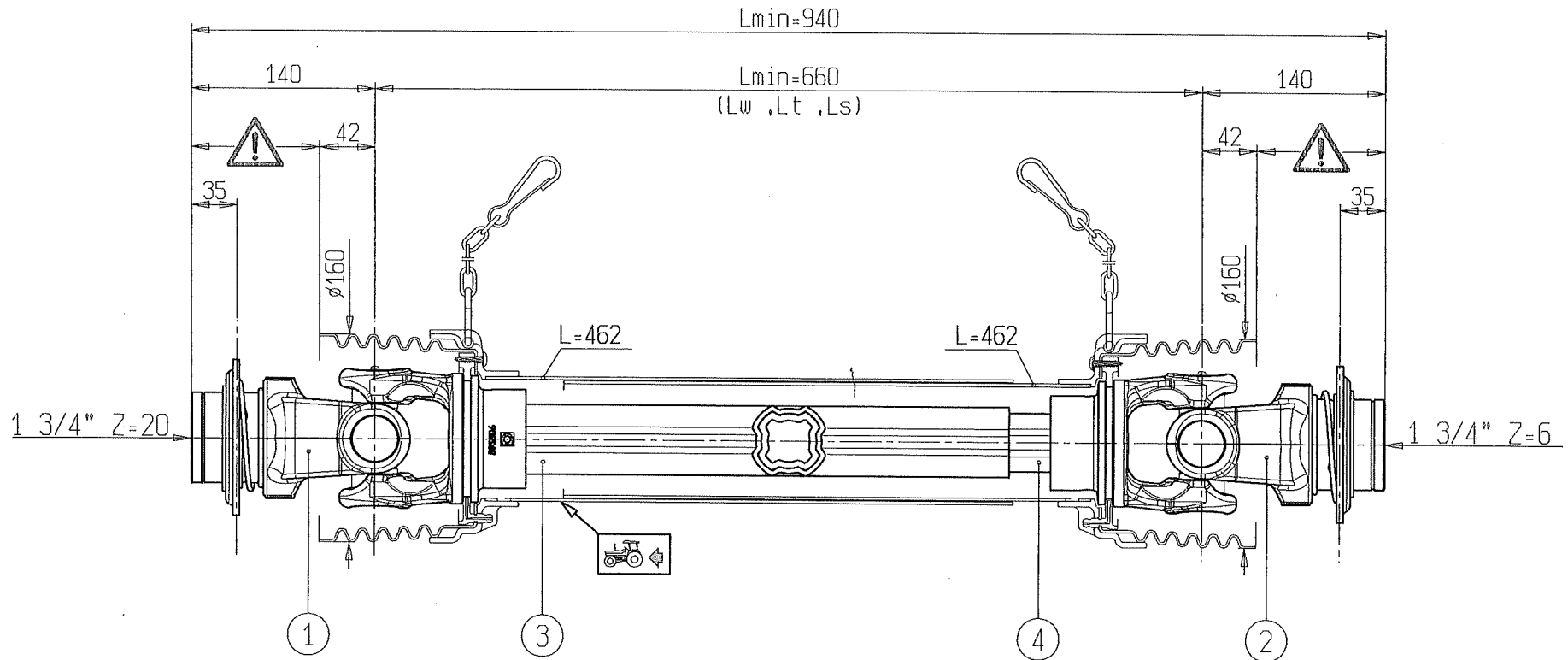

KRONOS 4000-4800





WARNING!

SECTIONS  OF THE ASSEMBLY MARKED ARE NOT SHIELDED AND MUST BE SHIELDED BY AN INTERACTIVE GUARDING SYSTEM. BONDIOLI & PAVESI DECLINES RESPONSIBILITY IF PROPER GUARDS ARE NOT PROVIDED OR MAINTAINED.

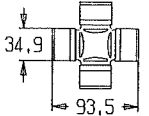
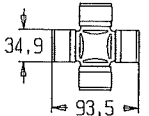
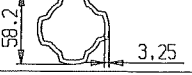

DRAFT

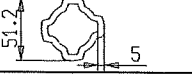
1	CODICE CODE R10	LATO TRATTORE TRACTOR SIDE	LATO MACCHINA IMPLEMENT SIDE	TIPO-TYPE SFT-S8	CLIENTE / CUSTOMER Solex	RIF. CLIENTE / CUSTOMER REF.	
2	CODICE CODE R09			DATA / DATE 22/12/2005	DISEGNATO / DESIGNED BY Jon C Cox	TIPO DI MACCHINA / TYPE OF IMPLEMENT	
3	 L=485	34,9 93,5	34,9 93,5	LUNGHEZZA MAX IN LAVORO MAX WORKING LENGTH LW=885	STUDIO / DESIGN	ORIGINE / ORIGIN	
4	 L=505	VELOCITA' MAX MAX SPEED 1000 min ⁻¹	M max 4000 Nm	LUNGHEZZA MAX TEMPORANEA MAX TEMPORARY LENGTH Lt=960 LUNGHEZZA MAX NON IN ROTAZIONE MAX LENGTH AT STANDSTILL Ls=997	NOTE / NOTES		

VIETATE LE RIPRODUZIONI NON AUTORIZZATE

TOUTE REPRODUCTION NON AUTORISEE EST INTERDITE

REPRODUCTION NOT PERMITTED

NICHT GEHEMIGTE VERVEELFAELTIGINGEN SIND UNZULAESSIG

PROHIBIDA LA RIPRODUCCION NO AUTORIZADA

CS9N069 R10R9