



Section Index

Muffler Selection by Style with Attenuation Ranges & Exhaust Flow

Use this section to select a replacement muffler by style back pressure and attenuation range

If you're looking for a replacement for an off-road application, consider our off-road exhaust mufflers. These newer, painted, aluminized steel mufflers have some unique features as compared to our standard line. These mufflers are the ones shown in blue text.

Style 1	55
Style 2	56
Style 2A & 3	57
Style 4 & 5.....	58
Style 6	59

Muffler Dimensions by Part Number..... 60

Use this section to verify the dimensional characteristics of a Donaldson muffler.

Muffler Dimensions by Style

Use this section to verify the dimensional characteristics of a Donaldson muffler.

Style 1	68
Style 2	70
Style 3	69
Style 4	72
Style 5	73
Style 6	74

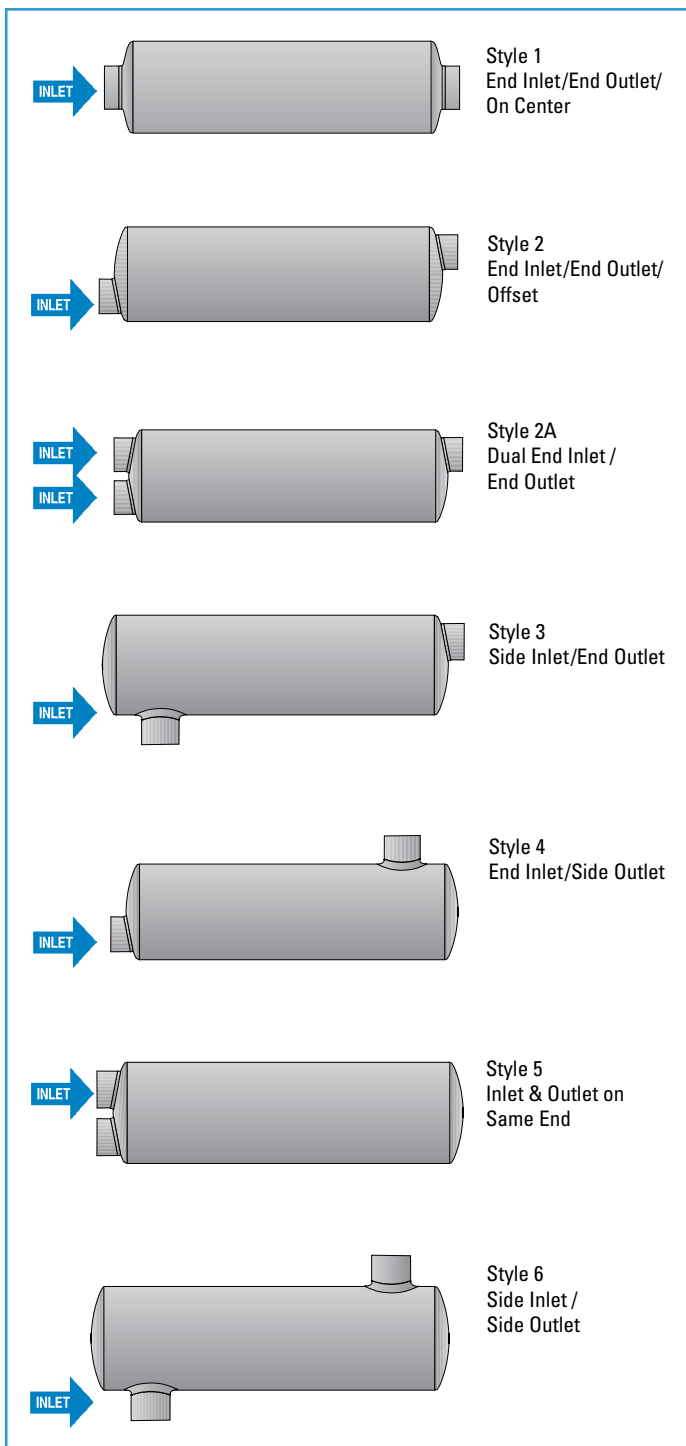

Selecting the Right Muffler for Your Engine

NOTE: Depending on your location, some diesel engines require the use of an emissions aftertreatment device to meet emissions regulations. In the United States, federal law prohibits the replacement of an emissions device (i.e., catalytic converter, combined catalytic converter/muffler, diesel particulate filter, etc.) with a non-emissions reducing (such as a straight pipe or conventional muffler) or un-approved emissions device. If operating the vehicle outside of the United States, make sure to check with and comply with any emission regulations for your locale.

Step 1

Determine the exhaust flow (CFM) and acceptable exhaust system backpressure of your engine, refer to your owners manual or contact your engine manufacturer for this information. To calculate exhaust flow, see our instructions on page 7.

Note: If you are spec'ing a dual muffler system divide engine's exhaust flow (CFM) by two.

Step 2

Find your muffler style (inlet/outlet positions and shape: round or oval) using the illustrations on the left. Proceed to the same style in page 53-57.

Step 3

Within the style, choose desired inlet diameter that is at or below your exhaust flow rate AND at or below the acceptable backpressure level.

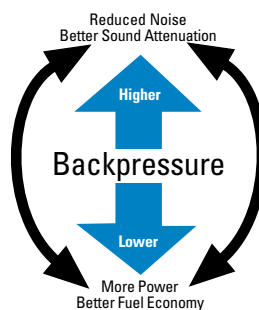

Muffler Size May Affect Backpressure:

Mufflers are key to vehicle and equipment performance because as the muffler decreases the sound, it may create more backpressure on exhaust flow. Typically, an increase in backpressure means decreased engine performance. A large muffler can be used to offset increased backpressure while maintaining overall acoustic performance.

Mufflers for Off-Road Use

Many of our mufflers are specifically designed for off-road equipment. These mufflers are shown in blue type on pages 53-59 and have the following features:

- High temperature black finish
- Mount or install in any position
- Aluminized steel construction
- All have round bodies with domed ends
- Slotted inlet/outlet connections



Choose the desired inlet diameter for the engine's air flow requirement that is at or below the acceptable backpressure level.

Style 1 - End Inlet/End Outlet/On Center

-- Inlet I.D. --		--- Outlet I.D. ---		Body Diameter		Body Length		Attenuation	Part	----- Exhaust Flow (cfm) @ -----		
inch	mm	inch	mm	inch	mm	inch	mm	Range dB(A)	Number	3" Hg 40.8" H ₂ O	2" Hg 27.2" H ₂ O	1" Hg 13.6" H ₂ O
2.00	51	2.00	51	6.00	152	15.75	400	12-18	M060479	498	393	283
		2.10 OD	53 OD	4.38	111	12.50	318	8-12	M045237	531	433	306
2.50	64	2.50	64	6.62	168	17.75	451	12-18	M065138	780	613	441
		2.63 OD	67 OD	6.62	168	15.00	381	6-12	M065071	790	645	456
2.89	73	3.16 OD	80	8.50	216	31.75	806	15-20	M085293 ⁷	1091	891	630
3.00	76	3.00	76	8.50	216	19.75	502	12-18	M085407	1125	884	636
		3.13 OD	80 OD	8.00	203	12.18	309	10-15	M080018	835	682	482
		4.00	102	11.00	279	36.00	914	13-19	M111029	2193	1791	1266
3.50	89	3.50	89	7.00	178	14.00	356	10-15	M070028	1245	1017	719
		3.50	89	9.00	229	21.75	552	12-18	M091046	1525	1203	865
		3.50	89	9.00	229	44.50	1130	18-25	M090146	1001	817	578
4.00	102	4.00	102	8.50	216	34.37	873	12-18	M085421	2099	1714	1212
		4.00	102	8.50	216	34.37	873	8-12	M085171	3119	2546	1800
		4.00	102	9.00	229	44.44	1129	13-18	M090544	2006	1638	1158
		4.00	102	9.00	229	20.00	508	10-15	M090594	1667	1361	962
		4.00	102	10.33	262	44.50	1130	25-35	M100464 ¹	1420	1159	820
		4.00	102	10.00	254	23.75	603	12-18	M101167	2000	1570	1130
		4.00	102	10.00	254	44.44	1129	12-18	M100466	1948	1590	1125
		4.00 OD	102 OD	9.00	229	29.31	744	10-15	M090095 ⁷	1628	1330	940
		5.00	127	9.00	229	44.44	1129	15-20	M090781	2639	2155	1524
		5.00	127	10.00	254	44.44	1129	19-25	M100695	1543	1260	891
		5.00	127	5.00	127	9.00	229	20.00	508	10-15	M090595	2478
5.00	127			9.00	229	44.44	1129	13-18	M090074	2887	2357	1667
5.00	127			9.00	229	44.44	1129	12-17	M090535	3260	3100	2340
5.00	127			10.00	254	44.44	1129	16-23	M100944	2950	2494	1765
5.00	127			10.00	254	44.44	1129	19-25	M100582	1600	1435	1015
5.00	127			10.00	254	44.44	1129	19-25	M101159 ⁴	1650	1465	1035
5.00	127			10.00	254	44.44	1129	19-25	M101182 ³	1650	1465	1035
5.00	127			10.00	254	44.44	1129	19-25	M100580	2530	2215	1565
5.00	127			10.00	254	44.44	1129	15-20	M100465	2790	2277	1610
5.00	127			10.00	254	44.44	1129	19-25	M101158 ⁴	2625	2305	1630
5.00	127			10.00	254	44.44	1129	19-25	M101181 ³	2625	2305	1630
5.00	127			10.00	254	44.44	1129	13-18	M100463	3260	3100	2340
5.00	127			10.00	254	44.44	1129	16-23	M101263	2530	2215	1565
5.00	127			10.00	254	59.95	1522	19-25	M100807	2610	2131	1507
5.00	127			11.00	279	50.50	1283	19-25	M110849	2950	2505	1775
5.00	127	11.84	301	25.75	654	12-18	M120747	3100	2450	1762		
2 NPT		2 NPT		6.00	152	14.50	368	8-12	M060247	776	633	448
2.5 NPT		2.5 NPT		6.00	152	15.00	381	8-12	M060005	773	631	446
3 NPT		3 NPT		7.00	178	14.00	356	10-15	M070008	1293	1056	747
3.5 NPT		3.5 NPT		7.00	178	18.38	467	10-15	M070050	1408	1149	813
4 NPT		4 NPT		9.00	229	20.00	508	10-15	M090009	1767	1443	1020

Mufflers in blue text have high temperature black finish and are designed for off-road applications.

- 1 - Wrapped muffler (reduces noise and surface temperature)
- 3 - Silent Partner™ Exhaust & Engine Brake Silencer-Aluminized
- 4 - Silent Partner™ Exhaust & Engine Brake Silencer-Stainless Steel
- 7 - Face flange on inlet

Muffler Selection by Style, Attenuation & Exhaust Flow



Stated backpressure levels include muffler, average tubing lengths, and accessories.

Style 2 - End Inlet/End Outlet/Offset

-- Inlet I.D. --		--- Outlet I.D. ---		Body Diameter		Body Length		Attenuation Range dB(A)	Part Number	----- Exhaust Flow (cfm) @ -----		
inch	mm	inch	mm	inch	mm	inch	mm			3" Hg 40.8" H ₂ O	2" Hg 27.2" H ₂ O	1" Hg 13.6" H ₂ O
2.00	51	2.00	51	6.00	152	15.75	400	12-18	M060480	498	393	283
		2.00	51	6.00	152	16.90	429	15-20	M060055	515	420	297
		2.00	51	6.00	152	24.00	610	15-20	M060232	515	420	297
2.50	64	2.50	64	6.62	168	17.75	451	12-18	M065139	780	613	441
		2.50	64	6.62	168	18.56	471	15-20	M065034	709	579	409
		2.50	64	6.62	168	27.75	705	16-22	M065065	709	579	1109
3.00	76	3.00	76	8.3 x 11.5	211 x 292	26.00	660	19-25	M090170	828	676	478
		3.00	76	8.50	216	19.75	502	12-18	M085408	1125	884	636
		3.00	76	8.50	216	20.50	521	15-20	M085056	1094	894	632
		3.00	76	8.50	216	27.50	699	18-22	M085078	964	787	557
		3.00	76	8.50	216	27.75	705	18-22	M085080	964	787	557
		3.00	76	8.50	216	31.25	794	17-22	M085023	1094	894	632
		3.00	76	8.5 x 11.8	216 x 300	26.00	660	19-25	M090159 ¹	828	676	478
		3.00	76	8.50	216	38.00	965	15-20	M085008	1124	918	649
3.50	89	3.50	89	8.3 x 11.5	211 x 292	26.00	660	15-20	M090158	1325	1081	765
		3.50	89	9.00	229	21.75	552	12-18	M091047	1525	1203	865
		3.50	89	8.5 x 11.8	216 x 300	26.00	660	15-20	M090210 ¹	1325	1081	765
		4.00	102	8.2 x 11.5	208 x 292	26.00	660	13-18	M090520	1719	1403	992
		4.00	102	8.2 x 11.5	208 x 292	30.00	762	13-18	M090680	1719	1403	992
4.00	102	3.50	89	8.2 x 11.5	208 x 292	26.00	660	16-21	M090538	1340	1094	773
		4.00	102	10.00	254	23.75	603	12-18	M101168	2000	1570	1130
		4.00	102	8.2 x 11.5	208 x 292	26.00	660	12-18	M090280	1719	1403	992
		4.00	102	8.2 x 11.5	208 x 292	26.00	660	13-18	M090534	1776	1450	1025
		4.00	102	10.00	254	27.12	689	15-20	M100048	1702	1390	983
		4.00	102	10.00	254	35.38	899	15-20	M100043	1702	1390	983
		4.00	102	10 x 15	254 x 381	26.00	660	15-20	M120100	1997	1631	1153
		4.00	102	10.3 x 15.3	261 x 389	42.00	1067	22-28	M120197 ¹	1386	1131	800
		4.00	102	11.00	279	30.00	762	15-20	M110012	1730	1412	999
		4.00	102	11.00	279	36.00	914	19-25	M110189	1819	1485	1050
4.00	102	11.12	282	34.75	883	19-25	M110028	1819	1485	1050		
4 OD	102 OD	5.00	127	11.00	279	36.00	914	13-19	M111028	2393	1954	1382
5.00	127	5.00	127	10 x 15	254 x 381	26.00	660	15-20	M120225	2887	2357	1667
		5.00	127	10 x 15	254 x 381	26.00	660	15-20	M120108	2329	1902	1345
		5.00	127	10 x 15	254 x 381	36.00	914	15-20	M120365	2265	1849	1307
		5.00	127	10 x 15	254 x 381	44.00	1118	13-18	M120448	2222	1814	1283
		5.00	127	11.00	279	44.00	1118	13-18	M110077	2205	1800	1273
		5.00	127	11.84	301	25.75	654	12-18	M120748	3100	2450	1762
6.00	152	6.00	152	10 x 15	254 x 381	31.75	806	10-15	M122300	3740	3054	2159
		6.00	152	12 x 18	305 x 457	30.00	762	11-16	M140048	3765	3074	2174
		6.00	152	14 x 21	357 x 533	35.00	889	12-18	M170101	4113	3358	2375
8.00	203	8.00	203	16 x 24	406 x 607	45.00	1143	11-15	M190002	6352	5186	3667

Choose the desired inlet diameter for the engine's air flow requirement that is at or below the acceptable backpressure level.



Choose the desired inlet diameter for the engine's air flow requirement that is at or below the acceptable backpressure level.

Style 2A - Dual End Inlet/End Outlet

-- Inlet I.D. --		--- Outlet I.D. ---		Body Diameter		Body Length		Attenuation Range dB(A)	Part Number	----- Exhaust Flow (cfm) @ -----		
inch	mm	inch	mm	inch	mm	inch	mm			3" Hg 40.8" H ₂ O	2" Hg 27.2" H ₂ O	1" Hg 13.6" H ₂ O
2.5 (2)	64 (2)	2.75	70	8.50	216	30.00	762	15-20	M085172	685	559	395
		3.00	76	8.50	216	31.25	794	15-20	M085189 ²	875	714	505
		3 OD	76 OD	8.75	222	30.12	765	19-25	M085267 ^{2,7}	1160	947	670
2.75 (2)	70 (2)	4.00	102	8.2 x 11.5	208 x 292	27.00	686	15-18	M090563	982	802	567

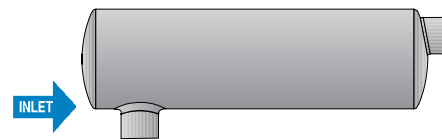

Mufflers in blue text have high temperature black finish and are designed for off-road applications.

Style 3 - Side Inlet/End Outlet

-- Inlet I.D. --		--- Outlet I.D. ---		Body Diameter		Body Length		Attenuation Range dB(A)	Part Number	----- Exhaust Flow (cfm) @ -----		
inch	mm	inch	mm	inch	mm	inch	mm			3" Hg 40.8" H ₂ O	2" Hg 27.2" H ₂ O	1" Hg 13.6" H ₂ O
1.68	43	1.64	42	4.38	111	13.78	350	12-18	M045193	220	180	127
2.00	51	2.00	51	6.00	152	15.75	400	12-18	M060481	498	393	283
		2.00	51	6.00	152	18.81	478	15-20	M060158	383	313	221
2.50	64	2.50	64	6.62	168	17.75	451	12-18	M065140	780	613	441
		2.50	64	6.62	168	20.89	531	15-20	M065044	564	461	326
3.00	76	3.00	76	8.50	216	19.75	502	12-18	M085409	1125	884	636
		3.00	76	8.80	224	27.12	689	15-20	M085226 ¹	808	659	466
3.02	77	3.00	76	8.50	216	26.25	667	15-20	M085090	808	659	466
3.50	89	3.00	76	8.50	216	27.00	686	12-18	M085084	801	654	462
		3.50	89	9.00	229	21.75	552	12-18	M091048	1525	1203	865
		3.50	89	8.3 x 11.5	211 x 292	26.13	664	15-20	M090301	1114	910	643
4.00	102	4.00	102	10.00	254	23.75	603	12-18	M101169	2000	1570	1130
		4.00	102	10.00	254	28.00	711	15-20	M100146	1341	1095	774
		4.00	102	11.00	279	33.00	838	15-20	M110674 ⁶	1677	1369	968
		4.00	102	11.00	279	36.00	914	19-25	M110479	1608	1313	928
		5.00	127	9.00	229	44.50	1130	15-20	M090823	2329	1902	1345
		5.00	127	11.84	301	32.13	816	12-18	M120598	2264	1848	1307
		5.00	127	10 x 15	254 x 381	21.00	533	12-17	M120566	2205	1800	1273
		3.85 OD	98 OD	10 x 15	254 x 381	15.00	381	12-18	M120382	2265	1849	1307
		Down Spout		11.00	279	36.00	914	13-19	M111024	1702	1390	983
5.00	127	5.00	127	10.00	254	44.50	1130	13-18	M100213	2415	1972	1394
		5.00	127	11.84	301	25.75	654	12-18	M120749	3100	2450	1762
		5.00	127	10 x 15	254 x 381	35.87	911	15-20	M120235	2098	1713	1211

1 - Wrapped muffler (reduces noise and surface temperature)
 2 - Stainless Steel
 6 - Band clamp on inlet tube
 7 - Face flange on inlet

Muffler Selection by Style, Attenuation & Exhaust Flow



Stated backpressure levels include muffler, average tubing lengths, and accessories.

Style 4 - End Inlet/Side Outlet

-- Inlet I.D. --		--- Outlet I.D. ---		Body Diameter		Body Length		Attenuation Range dB(A)	Part Number	----- Exhaust Flow (cfm) @ -----		
inch	mm	inch	mm	inch	mm	inch	mm			3" Hg 40.8" H ₂ O	2" Hg 27.2" H ₂ O	1" Hg 13.6" H ₂ O
2.00	51	2.00	51	6.00	152	15.75	400	12-18	M060481	498	393	283
2.50	64	2.50	64	6.62	168	17.75	451	12-18	M065140	780	613	441
3.00	76	3.00	76	8.50	216	19.75	502	12-18	M085409	1125	884	636
		3.00	76	8.50	216	26.25	667	15-20	M085206	715	583	413
3.50	89	3.50	89	9.00	229	21.75	552	12-18	M091048	1525	1203	865
		4.00	102	8.2 x 11.5	208 x 292	32.56	827	13-18	M090547	1500	1224	866
		4.00 OD	102 OD	8.2 x 11.5	208 x 292	32.56	827	13-18	M090548	1913	1562	1105
4.00	102	4.00	102	10.00	254	23.75	603	12-18	M101169	2000	1570	1130
		4.00	102	10.00	254	27.75	705	13-18	M100052	1679	1371	969
		4.00	102	11.00	279	36.00	914	15-21	M110112	1852	1512	1069
		4.00	102	11.00	279	36.00	914	15-21	M110148	1852	1512	1069
		4.00 OD	102 OD	11.00	279	36.00	914	15-21	M110311	1852	1512	1069
		4.00	102	10 x 15	254 x 381	30.38	772	15-20	M120367	1708	1394	986
4.00 OD	102 OD	4.00 OD	102 OD	11.00	279	36.00	914	15-21	M111025	1976	1613	1141
5.00	127	5.00	127	11.00	279	46.00	1168	15-20	M110014	2462	2010	1421
		5.00	127	11.84	301	25.75	654	12-18	M120749	3100	2450	1762
		5.00	127	10 x 15	254 x 381	36.00	914	15-20	M120366	2400	1960	1386

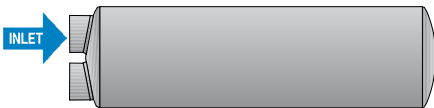

Mufflers in blue text have high temperature black finish and are designed for off-road applications.

Style 5 - Inlet & Outlet on Same End

-- Inlet I.D. --		--- Outlet I.D. ---		Body Diameter		Body Length		Attenuation Range dB(A)	Part Number	----- Exhaust Flow (cfm) @ -----		
inch	mm	inch	mm	inch	mm	inch	mm			3" Hg 40.8" H ₂ O	2" Hg 27.2" H ₂ O	1" Hg 13.6" H ₂ O
2.00	51	2.00	51	6.00	152	15.75	400	12-18	M060482	498	393	283
		2.00	51	6.00	152	16.90	429	15-20	M060250	513	419	296
2.50	64	2.50	64	6.62	168	17.75	451	12-18	M065141	780	613	441
		2.50	64	6.62	168	20.00	508	15-20	M065073	718	586	414
3.00	76	3.00	76	8.50	216	22.00	559	15-20	M085207	1087	888	628
		3.00	76	8.50	216	19.75	502	12-18	M085410	1125	884	636
3.50	89	3.50	89	9.00	229	21.75	552	12-18	M091049	1525	1203	865
4.00	102	4.00	102	10.00	254	23.75	603	12-18	M101170	2000	1570	1130
		4.00	102	10.00	254	27.75	705	15-20	M100049	1450	1184	837
		4.00	102	10 x 15	254 x 381	26.00	660	18-20	M120154	1390	1135	803
		5.00	127	10 x 15	254 x 381	27.00	686	15-20	M120713	2069	1689	1159
5.00	127	5.00	127	10 x 15	254 x 381	26.25	667	15-20	M120176	2046	1670	1181
		5.00	127	10 x 15	254 x 381	26.00	660	8-12	M120131	2913	2378	1682
		5.00	127	10 x 15	254 x 381	33.38	848	19-25	M120189	2050	1674	1184
		5.00	127	10 x 15	254 x 381	44.00	1118	13-18	M120450	2679	2188	1547
		5.00	127	11.84	301	25.75	654	12-18	M120750	3100	2450	1762

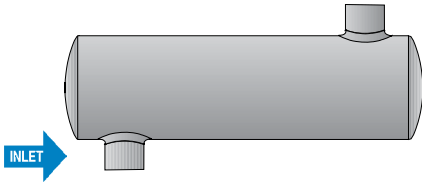

Stated backpressure levels include muffler, average tubing lengths, and accessories.

Style 6 - Side Inlet/Side Outlet

-- Inlet I.D. --		--- Outlet I.D. ---		Body Diameter		Body Length		Attenuation	Part Number	----- Exhaust Flow (cfm) @ -----		
inch	mm	inch	mm	inch	mm	inch	mm	Range dB(A)		3" Hg 40.8" H ₂ O	2" Hg 27.2" H ₂ O	1" Hg 13.6" H ₂ O
2.00	51	2.00	51	6.00	152	15.50	394	12-18	M060483	498	393	283
		2.00	51	6.00	152	18.81	478	12-18	M060251	487	398	281
2.50	64	2.50	64	6.62	168	17.50	444	12-18	M065142	780	613	441
		2.50	64	6.62	168	20.81	529	15-20	M065074	692	565	400
3.00	76	3.00	76	8.50	216	27.00	686	12-18	M085284	708	578	409
		3.00	76	8.50	216	19.50	495	12-18	M085411	1125	884	636
		3.00	76	8.50	216	27.00	686	15-20	M085208	1043	651	602
3.50	89	3.50	89	8.3 x 11.5	211 x 292	26.00	660	15-20	M090598	1164	950	672
		3.50	89	9.00	229	21.50	546	12-18	M091050	1525	1203	865
4.00	102	4.00	102	10.00	254	23.50	597	12-18	M101171	2000	1570	1130
		4.00	102	10.12	257	28.00	711	15-20	M100572	1659	1355	958
		4 OD	102 OD	11.00	279	36.00	914	13-19	M111026	1887	1541	1090
5.00	127	5.00	127	11.84	301	25.50	648	12-18	M120751	3100	2450	1762
		5.00	127	10 x 15	254 x 381	28.00	711	15-20	M120418	2350	1919	1357

Mufflers in blue text have high temperature black finish and are designed for off-road applications.

Choose the desired inlet diameter for the engine's air flow requirement that is at or below the acceptable backpressure level.

MUFFLER SPECS

Style 1 - End Inlet /End Outlet /On Center

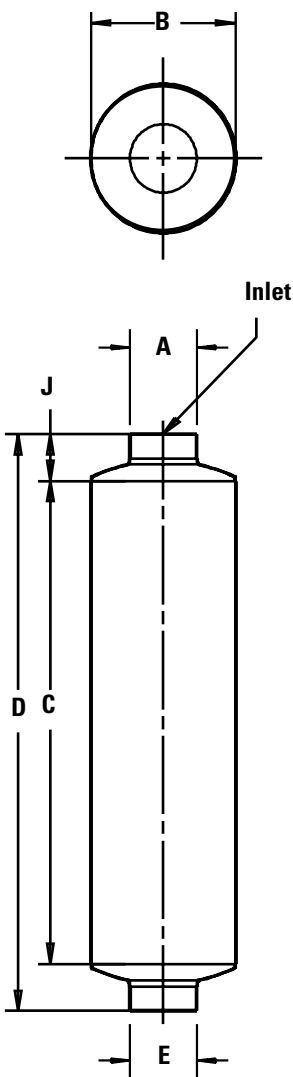

Style 2 - End Inlet /End Outlet /Offset

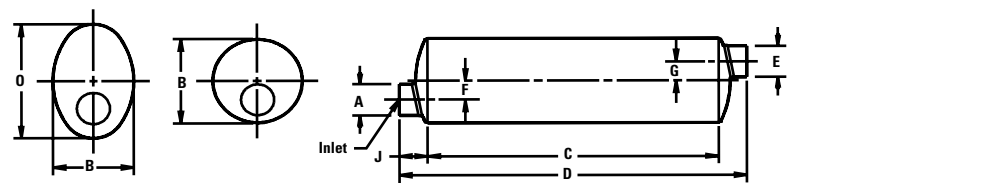

Style 2A - Dual End Inlet /End Outlet

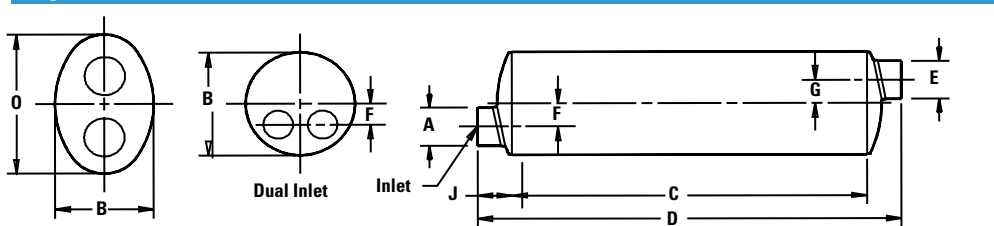

Style 3 - Side Inlet /End Outlet

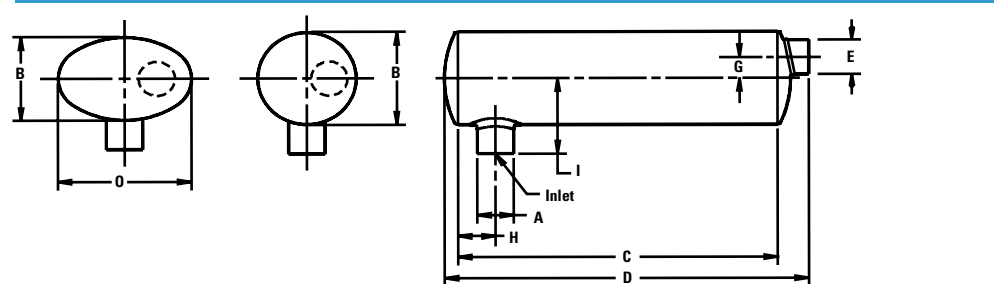

Style 4 - End Inlet /Side Outlet

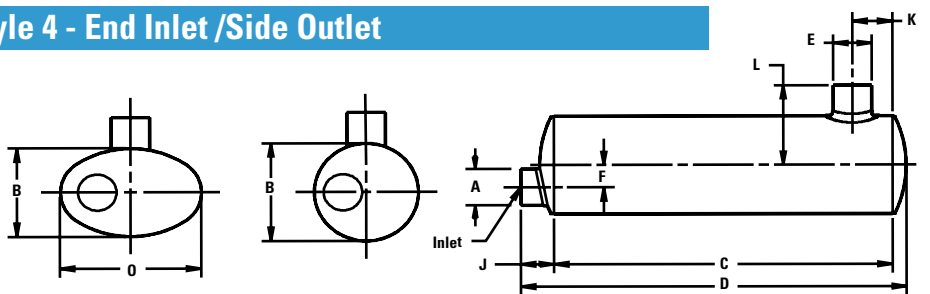

Style 5 - Inlet & Outlet on Same End

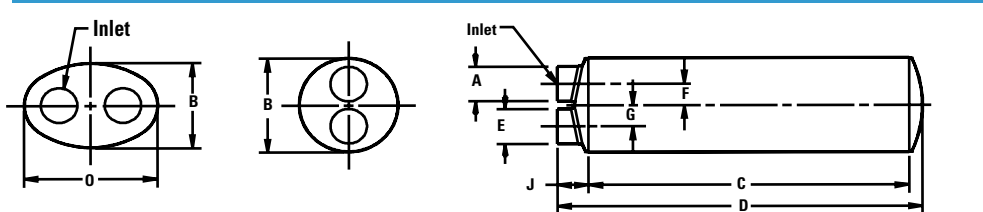

Style 6 - Side Inlet /Side Outlet

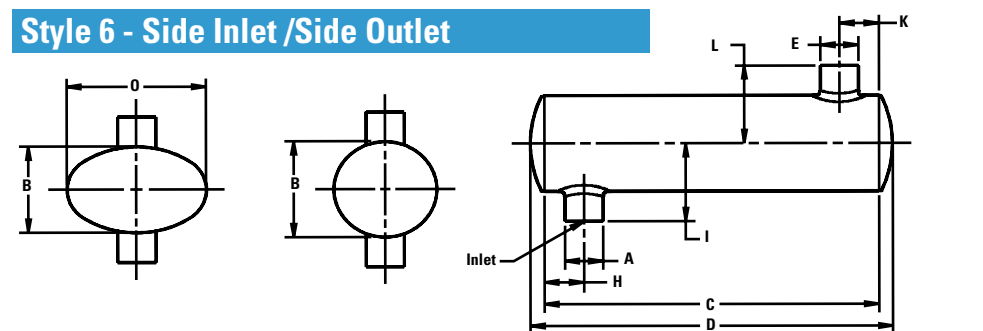

Part Number	Muffler Style	Body				Outlet I.D. (E)	Offset		Inlet Tube			Outlet Tube from End Center		Clock Position Inlet	Clock Position Outlet	Wgt lbs. kg
		Inlet I.D. (A)	Dia. (B) or (BxO)	Length (C)	Overall Length (D)		Inlet (F)	Outlet (G)	Loc. (H)	Length (I)	Length (J)	(K)	(L)			
M045193	3	1.68 43	4.38 111	13.78 350	15.78 401	1.64 42			2.75 70	4.00 102			12:00		4 2	
M045237	1	2.00 51	4.38 111	12.50 318	17.00 432	2.10 OD 53 OD					2.50 64				4 2	
M060005	1	2.5 NPT	6.00 152	15.00 381	18.12 460	2.5NPT					1.56 40				9 4	
M060055	2	2.00 51	6.00 152	16.90 429	21.90 556	2.00 51	1.50 38	1.50 38			2.50 64		6:00 12:00		7 3	
M060158	3	2.00 51	6.00 152	18.81 478	21.50 546	2.00 51		1.50 38	3.50 89	5.00 127			3:00 6:00		9 4	
M060232	2	2.00 51	6.00 152	24.00 610	29.00 737	2.00 51	1.50 38	1.50 38			2.50 64		6:00 12:00		9 4	
M060247	1	2 NPT	6.00 152	14.50 368	20.00 508	2 NPT					2.75 70				7 3	
M060250	5	2.00 51	6.00 152	16.90 429	19.40 493	2.00 51	1.50 38	1.50 38			2.50 64		6:00 12:00		8 4	
M060251	6	2.00 51	6.00 152	18.81 478	18.81 478	2.00 51			3.50 89	5.00 127		3.50 89	5.00 127	6:00 12:00	8 4	
M060479 ⁹	1	2.00 51	6.00 152	15.75 400	21.00 533	2.00 51					2.62 67				7.6 3.4	
M060480 ⁸	2	2.00 51	6.00 152	15.75 400	21.00 533	2.00 51	1.50 38	1.50 38			2.62 67		6:00 12:00		7.6 3.4	
M060481 ⁹	3/4	2.00 51	6.00 152	15.75 400	19.25 489	2.00 51			1.88 48	5.00 127			6:00		7.6 3.4	
M060482 ⁸	5	2.00 51	6.00 152	15.75 400	19.25 489	2.00 51	1.50 38	1.50 38			2.62 67				8.4 3.8	
M060483 ⁸	6	2.00 51	6.00 152	15.50 394	17.24 438	2.00 51			1.75 44	5.00 127		1.75 44	5.00 127	6:00 12:00	7.4 3.4	
M065034	2	2.50 64	6.62 168	18.56 471	23.00 584	2.50 64	1.62 41	1.62 41			1.50 38		6:00 12:00		9 4	
M065044	3	2.50 64	6.62 168	20.89 531	23.50 597	2.50 64		1.62 41	3.50 89	6.00 152			6:00 9:00		12 5	
M065065	2	2.50 64	6.62 168	27.75 705	35.00 889	2.50 64	1.62 41	1.62 41			3.50 89		6:00 12:00		13 6	
M065071	1	2.50 64	6.62 168	15.00 381	22.00 559	2.60 OD 66 OD					3.50 89				7 3	
M065073	5	2.50 64	6.62 168	20.00 508	21.50 546	2.50 64	1.62 41	1.62 41			1.50 38		6:00 12:00		10 5	
M065074	6	2.50 64	6.62 168	20.81 529	20.81 529	2.50 64			3.50 89	6.00 152		3.50 89	6.00 152	6:00 12:00	10 5	
M065138 ⁸	1	2.50 64	6.62 168	17.75 451	24.00 610	2.50 64					3.12 79				9.8 4.5	
M065139 ⁸	2	2.50 64	6.62 168	17.75 451	24.00 610	2.50 64	1.62 41	1.62 41			3.12 79		6:00 12:00		9.8 4.5	
M065140 ⁹	3/4	2.50 64	6.62 168	17.75 451	22.04 560	2.50 64			2.38 60	5.75 146			6:00		10 4.5	
M065141 ⁸	5	2.50 64	6.62 168	17.75 451	22.04 560	2.50 64	1.63 41	1.63 41			3.12 79		6:00 12:00		10.6 4.8	
M065142 ⁸	6	2.50 64	6.62 168	17.50 444	19.84 504	2.50 64			2.50 64	5.75 146		2.25 57	5.75 146	6:00 12:00	9.4 4.2	

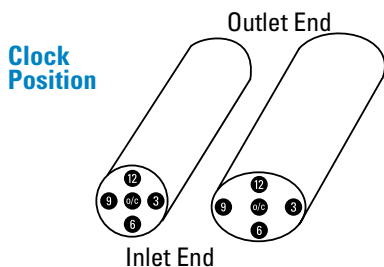

Footnotes

- 1 Wrapped muffler (reduces noise and surface temperature)
- 2 Stainless Steel
- 3 Silent Partner™ Muffler -Aluminized
- 4 Silent Partner™ Muffler -Stainless Steel
- 5 Resonator
- 6 Band clamp on inlet tube
- 7 Face flange on inlet
- 8 Made for off-road use
- 9 Made for off-road use, flows in either direction

Muffler Specifications by Part Number



MUFFLER SPECS

Part Number	Muffler Style	Body				Outlet I.D. (E)	Offset		Inlet Tube			Outlet Tube from End Center		Clock Position		Wgt lbs. kg
		Inlet I.D. (A)	Dia. (B) or (BxO)	Length (C)	Overall Length (D)		Inlet (F)	Outlet (G)	Loc. (H)	Length (I)	Length (J)	End Center (K)	(L)	Inlet	Outlet	
M070008	1	3 NPT	7.00 178	14.00 356	19.75 502	3 NPT					2.38 60					13 6
M070028	1	3.50 89	7.00 178	14.00 356	19.75 502	3.50 89					2.38 60					10 5
M070050	1	3.5 NPT	7.00 178	18.38 467	25.62 651	3.5 NPT					3.00 76					18 8
M080018	1	3.00 76	8.00 203	12.18 309	17.00 432	3.13 OD 80 OD					1.38 35					10 5
M085008	2	3.50 89	8.50 216	38.00 965	43.00 1092	3.00 76	1.75 44	2.00 51			2.50 64			6:00 12:00		23 10
M085023	2	3.00 76	8.50 216	31.25 794	36.25 921	3.00 76	2.00 51	2.00 51			2.50 64			6:00 12:00		19 9
M085056	2	3.00 76	8.50 216	20.50 521	25.00 635	3.00 76	2.00 51	2.00 51			1.50 38			6:00 12:00		14 6
M085078	2	3.00 76	8.50 216	27.50 699	32.00 813	3.00 76	2.00 51	2.00 51			1.50 38			6:00 12:00		20 9
M085080	2	3.00 76	8.50 216	27.75 705	33.75 857	3.00 76	2.00 51	2.00 51			3.50 89			6:00 6:00		20 9
M085084	3	3.50 89	8.50 216	27.00 686	29.50 749	3.00 76		2.00 51	4.50 114	7.25 184				3:00 6:00		20 9
M085090	3	3.02 77	8.50 216	26.25 667	29.50 749	3.00 76		2.00 51	3.50 89	6.75 171				3:00 6:00		20 9
M085171	1	4.00 102	8.50 216	34.37 873	40.00 1016	4.00 102					2.50 64					21 10
M085172	2A	2.50 (2) 64 (2)	8.50 216	30.00 762	39.00 991	2.75 70	1.62 (2) 41 (2)	2.00 51			2.50 (2) 64 (2)			6:00(2) 6:00		24 11
M085189 ²	2A	2.50 (2) 64 (2)	8.50 216	31.25 794	36.25 921	3.00 76	1.62 (2) 41 (2)	2.00 51			2.50 (2) 64 (2)			6:00 (2) 12:00		23 10
M085206	4	3.00 76	8.50 216	26.25 667	29.50 749	3.00 76	2.00 51				3.25 83	3.50 89	6.75 171	6:00 9:00		20 9
M085207	5	3.00 76	8.50 216	22.00 559	23.50 597	3.00 76	2.00 51	2.00 51			1.50 38			6:00 12:00		16 7
M085208	6	3.00 76	8.50 216	27.00 686	27.00 686	3.00 76			3.50 89	6.75 171		3.50 89	6.75 171	6:00 12:00		17 8
M085226 ¹	3	3.00 76	8.80 224	27.12 689	29.56 751	3.00 76		2.00 51	4.56 116	6.75 171				3:00 6:00		28 13
M085267 ^{1,2}	2A	2.50 (2) ⁷ 64 (2) ⁷	8.75 222	30.12 765	38.97 990	3 OD 76 OD	1.62 (2) 41 (2)	2.00 51			5.72/3.22 146/82			6:00 (2) 12:00		32 15
M085284	6	3.00 76	8.50 216	27.00 686	27.00 686	3.00 76			3.50 89	6.75 171		3.50 89	6.75 171	6:00 12:00		19 9
M085293	1	2.89 ⁷ 73 ⁷	8.50 216	31.75 806	46.25 1175	3.16 OD 80 OD										28 12
M085407 ⁸	1	3.00 76	8.50 216	19.75 502	26.50 673	3.00 76					3.38 86					15.2 7
M085408 ⁸	2	3.00 76	8.50 216	19.75 502	26.50 673	3.00 76	2.00 51	2.00 51			3.38 86			6:00 12:00		15.2 7
M085409 ⁹	3/4	3.00 76	8.50 216	19.75 502	24.27 616	3.00 76			2.88 73	6.50 165				6:00		15.4 7
M085410 ⁸	5	3.00 76	8.50 216	19.75 502	24.27 616	3.00 76	2.00 51	2.00 51			3.38 86			6:00 12:00		17 7.7
M085411 ⁸	6	3.00 76	8.50 216	19.50 495	21.78 553	3.00 76			3.00 76	6.50 165		3.00 76	6.50 165	6:00 12:00		14.2 6.4
M085421	1	4.00 102	8.50 216	34.37 873	40.00 1016	4.00 102					2.50 64					21 10
M090009	1	4 NPT	9.00 229	20.00 508	26.00 660	4 NPT					3.00 76					23 10
M090072 ⁵	1	5.00 127	9.00 229	10.00 254	16.50 419	5.00 127					3.00 76					9 4

Part Number	Muffler Style	----- Body -----				Outlet I.D. (E)	---- Offset ----		----- Inlet Tube -----			Outlet Tube from End Center (K) (L)	Clock Position		Wgt lbs. kg	
		Inlet I.D. (A)	Dia. (B) or (BxO)	Length (C)	Overall Length (D)		Inlet (F)	Outlet (G)	Loc. (H)	Length (I)	Length (J)		Inlet	Outlet		
M090074	1	5.00 127	9.00 229	44.44 1129	51.00 1295	5.00 127					3.00 76				29 13	
M090095	1	4.00 ⁷ 102 ⁷	9.00 229	29.31 744	73.00 1854	4 OD 102 OD									33 15	
M090146	1	3.50 89	9.00 229	44.50 1130	51.00 1295	3.50 89					3.00 76				32 15	
M090158	2	3.50 89	8.3 x11.5 211 x 292	26.00 660	32.25 819	3.50 89	2.50 64	2.50 64			3.12 79		3:00	9:00	24 11	
M090159 ¹	2	3.00 76	8.5 x11.8 216 x 300	26.00 660	33.75 857	3.00 76	2.50 64	2.50 64			3.88 99		3:00	3:00	29 13	
M090170	2	3.00 76	8.3 x11.5 211 x 292	26.00 660	33.75 857	3.00 76	2.50 64	2.50 64			3.88 99		3:00	3:00	20 9	
M090210 ¹	2	3.50 89	8.5 x11.8 216 x 300	26.00 660	32.25 819	3.50 89	2.50 64	2.50 64			3.12 79		3:00	9:00	34 15	
M090280	2	4.00 102	8.2 x11.5 208 x 292	26.00 660	32.25 819	4.00 102	2.50 64	2.50 64			3.12 79		3:00	9:00	22 10	
M090301	3	3.50 89	8.3 x11.5 211 x 292	26.13 664	29.25 743	3.50 89		2.50 64	3.25 83	7.00 178			6:00	9:00	23 10	
M090362 ⁵	1	4.00 102	9.00 229	10.00 254	16.50 419	4.00 102					3.00 76				9 4	
M090520	2	3.50 89	8.2 x11.5 208 x 292	26.00 660	32.25 819	4.00 102	2.50 64	2.50 64			3.12 79		3:00	9:00	21 10	
M090534	2	4.00 102	8.2 x11.5 208 x 292	26.00 660	33.75 857	4.00 102	2.50 64	2.50 64			3.88 99		3:00	9:00	26 12	
M090535	1	5.00 127	9.00 229	44.44 1129	51.00 1295	5.00 127					3.00 76				30 14	
M090538	2	4.00 102	8.2 x11.5 208 x 292	26.00 660	32.25 819	3.50 89	2.50 64	2.50 64			3.12 79		3:00	12:00	26 12	
M090544	1	4.00 102	9.00 229	44.44 1129	51.00 1295	4.00 102					3.00 76				27 12	
M090547	4	3.50 89	8.2 x11.5 208 x 292	32.56 827	35.16 893	4.00 102	2.50 64				2.60 66	20.48 520	6.00 152	9:00	7:00	22 10
M090548	4	3.50 89	8.2 x11.5 208 x 292	32.56 827	35.16 893	4 OD 102 OD	2.50 64				2.60 66	20.48 520	8.70 221	3:00	7:30	21 10
M090563	2A	2.75 (2) 70 (2)	8.2 x11.5 208 x 292	27.00 686	32.75 832	4.00 102	0.15/4.00 9/102	2.50 64			2.63 (2) 67 (2)			9:00-3:00	3:00	22 10
M090594	1	4.00 102	9.00 229	20.00 508	26.50 673	4.00 102					3.00 76				14 6	
M090595	1	5.00 127	9.00 229	20.00 508	26.50 673	5.00 127					3.00 76				15 7	
M090598	6	3.50 89	8.3 x11.5 211 x 292	26.00 660	26.00 660	3.50 89			3.38 86	7.00 178		3.38 86	7.00 178	6:00	12:00	20 9
M090680	2	3.50 89	8.2 x11.5 208 x 292	30.00 762	36.25 921	4.00 102	2.50 64	2.50 64			3.12 79		3:00	9:00	25 11	
M090781	1	4.00 102	9.00 229	44.44 1129	51.00 1295	5.00 127					3.00 76				30 14	
M090823	3	4.00 102	9.00 229	44.50 1130	48.00 1219	5.00 127			3.81 97	6.69 170			6:00		30 13	
M091046 ⁸	1	3.50 89	9.00 229	21.75 552	29.00 737	3.50 89					3.62 89				15.8 7.2	

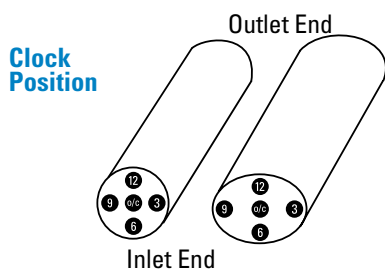

Footnotes

- 1 Wrapped muffler (reduces noise and surface temperature)
- 2 Stainless Steel
- 3 Silent Partner™ Muffler -Aluminized
- 4 Silent Partner™ Muffler -Stainless Steel
- 5 Resonator
- 6 Band clamp on inlet tube
- 7 Face flange on inlet
- 8 Made for off-road use
- 9 Made for off-road use, flows in either direction

Muffler Specifications by Part Number



MUFFLER SPECS

Part Number	Muffler Style	Body				Outlet I.D. (E)	Offset		Inlet Tube			Outlet Tube from End Center		Clock Position		Wgt lbs. kg
		Inlet I.D. (A)	Dia. (B) or (BxO)	Length (C)	Overall Length (D)		Inlet (F)	Outlet (G)	Loc. (H)	Length (I)	Length (J)	End Center (K)	(L)	Inlet	Outlet	
M091047 ⁸	2	3.50 89	9.00 229	21.75 552	29.00 737	3.50 89	2.10 53	2.10 53			3.62 89			6:00	12:00	15.8 7.2
M091048 ⁹	3/4	3.50 89	9.00 229	21.75 552	26.38 670	3.50 89			3.38 86	7.25 184				6:00		15.9 7.2
M091049 ⁸	5	3.50 89	9.00 229	21.75 552	26.44 672	3.50 89	2.10 53	2.10 53			3.62 89			6:00	12:00	17.3 7.9
M091050 ⁸	6	3.50 89	9.00 229	21.50 546	23.64 600	3.50 89			3.25 83	7.25 184		3.25 83	7.25 184	6:00	12:00	15.1 6.9
M100043	2	4.00 102	10.00 254	35.38 899	41.75 1060	4.00 102	2.44 62	2.44 62			2.88 73			6:00	12:00	32 15
M100048	2	4.00 102	10.00 254	27.12 689	33.50 851	4.00 102	2.44 62	2.44 62			2.88 73			6:00	12:00	27 12
M100049	5	4.00 102	10.00 254	27.75 705	30.62 778	4.00 102	2.44 62	2.44 62			2.88 73			12:00	6:00	23 10
M100052	4	4.00 102	10.00 254	27.75 705	30.75 781	4.00 102	2.44 62				3.00 76	24.25 616	8.75 222	6:00	2:00	25 11
M100146	3	4.00 102	10.00 254	28.00 711	32.00 813	4.00 102		2.44 62	4.50 114	8.00 203				6:00	9:00	27 12
M100213	3	5.00 127	10.00 254	44.50 1130	48.00 1219	5.00 127			5.50 140	7.50 191				6:00		33 15
M100463	1	5.00 127	10.00 254	44.44 1129	51.00 1295	5.00 127					3.00 76					31 14
M100464 ¹	1	4.00 102	10.33 262	44.50 1130	51.00 1295	4.00 102					3.00 76					52 24
M100465	1	5.00 127	10.00 254	44.44 1129	51.00 1295	5.00 127					3.00 76					28 13
M100466	1	4.00 102	10.00 254	44.44 1129	51.00 1295	4.00 102					3.00 76					27 12
M100572	6	4.00 102	10.12 257	28.00 711	30.62 778	4.00 102			4.50 114	8.00 203		4.50 114	8.00 203	6:00	12:00	22 10
M100580	1	5.00 127	10.00 254	44.44 1129	51.00 1295	5.00 127					3.00 76					29 13
M100582	1	5.00 127	10.00 254	44.44 1129	51.00 1295	5.00 127					3.00 76					31 14
M100695	1	4.00 102	10.00 254	44.44 1129	51.00 1295	5.00 127					3.00 76					30 14
M100807	1	5.00 127	10.00 254	59.94 1522	66.50 1689	5.00 127					3.00 76					48 22
M100944	1	5.00 127	10.00 254	44.44 1129	51.00 1295	5.00 127					3.00 76					32 15
M101158 ⁴	1	5.00 127	10.00 254	44.44 1129	51.00 1295	5.00 127					3.00 76					43 20
M101159 ⁴	1	5.00 127	10.00 254	44.44 1129	51.00 1295	5.00 127					3.00 76					43 20
M101167 ⁸	1	4.00 102	10.00 254	23.75 603	32.00 813	4.00 102					4.12 105					19.3 8.8
M101168 ⁸	2	4.00 102	10.00 254	23.75 603	32.00 813	4.00 102	2.44 62	2.44 62			4.12 105			6:00	12:00	19.3 8.8
M101169 ⁹	3/4	4.00 102	10.00 254	23.75 603	29.24 743	4.00 102			3.88 99	8.00 203				6:00		19.8 9
M101170 ⁸	5	4.00 102	10.00 254	23.75 603	29.24 743	4.00 102	2.44 62	2.44 62			4.12 105			6:00	12:00	22 10
M101171 ⁸	6	4.00 102	10.00 254	23.50 597	26.24 666	4.00 102			3.75 95	8.00 203		3.75 95	8.00 203	6:00	12:00	19.1 8.7
M101181 ³	1	5.00 127	10.00 254	44.44 1129	51.00 1295	5.00 127					3.00 76					43 20
M101182 ³	1	5.00 127	10.00 254	44.44 1129	51.00 1295	5.00 127					3.00 76					43 20

Part Number	Muffler Style	----- Body -----				Outlet I.D. (E)	---- Offset ----			----- Inlet Tube -----			Outlet Tube from End Center (K) (L)		Clock Position Inlet Outlet		Wgt lbs. kg
		Inlet I.D. (A)	Dia. (B) or (BxO)	Length (C)	Overall Length (D)		Inlet (F)	Outlet (G)	Loc. (H)	Length (I)	Length (J)	Inlet	Outlet	Inlet	Outlet		
M101263	1	5.00 127	10.00 254	44.44 1129	53.00 1346	5.00 127						3.00 76					31 14
M110012	2	4.00 102	11.00 279	30.00 762	36.00 914	4.00 102	2.50 64	2.50 64				3.00 76			6:00	12:00	26 12
M110014	4	5.00 127	11.00 279	46.00 1168	51.75 1314	5.00 127	2.50 64					4.25 108	38.50 978	8.50 216	6:00	12:00	45 20
M110028	2	4.00 102	11.12 282	34.75 883	42.50 1080	4.00 102	3.12 79	3.12 79				4.25 108			6:00	12:00	41 19
M110077	2	5.00 127	11.00 279	44.00 1118	50.00 1270	5.00 127	2.50 64	2.50 64				3.00 76			6:00	12:00	44 20
M110112	4	4.00 102	11.00 279	36.00 914	39.00 991	4.00 102	2.50 64					3.00 76	15.97 406	8.64 219	6:00	9:00	29 13
M110148	4	4.00 102	11.00 279	36.00 914	39.00 991	4.00 102	2.50 64					3.00 76	17.25 438	8.64 219	6:00	12:00	29 13
M110189	2	4.00 102	11.00 279	36.00 914	41.25 1048	4.00 102	2.50 64	2.50 64				2.63 67			6:00	12:00	34 15
M110311	4	4.00 OD 102	11.00 279	36.00 914	41.00 1041	4.00 102	2.50 64					5.00 127	27.10 688	8.64 219	6:00	12:00	27 12
M110479	3	4.00 102	11.00 279	36.00 914	39.00 991	4.00 102		2.50 64	4.25 108	8.64 219					6:00	3:00	31 14
M110674 ⁶	3	4.00 102	11.00 279	33.00 838	36.00 914	4.00 102			3.75 95	8.64 219					6:00		27 12
M110849	1	5.00 127	11.00 279	50.50 1283	57.00 1448	5.00 127						3.00 76					48 22
M111024	3	4.00 102	11.00 279	36.00 914	44.59 1133	Down Spout			3.75 95	8.64 219					12:00	6:00	34 15
M111025	4	4 OD 102 OD	11.00 279	36.00 914	41.00 1041	4 OD 102 OD					5.00 127	19.66 499	10.50 267		6:00		27 12
M111026	6	4.00 102	11.00 279	36.00 914	36.00 914	4 OD 102 OD			3.75 95	8.64 219		9.23 234	9.50 241	12:00	9:00	29 13	
M111028	2	4 OD 102 OD	11.00 279	36.00 914	44.00 1118	5.00 127		2.50 64			5.00 127				12:00		36 16
M111029	1	3.00 76	11.00 279	36.00 914	42.00 1067	4.00 102						3.00 76					34 15
M120100	2	4.00 102	10 x15 254 x 381	26.00 660	32.50 826	4.00 102	4.25 108	4.25 108				3.25 83			3:00	9:00	30 14
M120108	2	5.00 127	10 x15 254 x 381	26.00 660	32.50 826	5.00 127	3.12 79	3.12 79				3.25 83			3:00	9:00	34 15
M120131	5	5.00 127	10 x15 254 x 381	26.00 660	29.39 747	5.00 127	3.12 79	3.12 79				3.25 83			3:00	9:00	32 15
M120154	5	4.00 102	10 x15 254 x 381	26.00 660	28.38 721	4.00 102	4.25 108	4.25 108				2.25 57			3:00	9:00	31 14
M120176	5	5.00 127	10 x15 254 x 381	26.25 667	29.38 746	5.00 127	3.12 79	3.12 79				3.00 76			3:00	9:00	29 13
M120189	5	5.00 127	10 x15 254 x 381	33.38 848	39.50 1003	5.00 127	3.59 91	3.59 91				4.44 113			3:00	9:00	46 21
M120197 ¹	2	4.00 102	10.3 x15.3 261 x 389	36.00 914	42.00 1067	4.00 102	4.25 108	0.50 13				3.00 76			3:00	9:00	58 26
M120225	2	5.00 127	10 x15 254 x 381	26.00 660	32.50 826	5.00 127	3.12 79	3.12 79				3.25 86			3:00	9:00	31 14

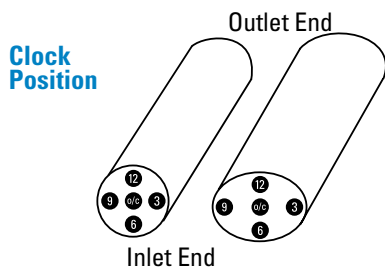

Footnotes

- 1 Wrapped muffler (reduces noise and surface temperature)
- 2 Stainless Steel
- 3 Silent Partner™ Muffler -Aluminized
- 4 Silent Partner™ Muffler -Stainless Steel
- 5 Resonator
- 6 Band clamp on inlet tube
- 7 Face flange on inlet
- 8 Made for off-road use
- 9 Made for off-road use, flows in either direction

Muffler Specifications by Part Number

MUFFLER SPECS

Part Number	Muffler Style	Body				Outlet I.D. (E)	Offset		Inlet Tube			Outlet Tube from End Center		Clock Position		Wgt lbs. kg
		Inlet I.D. (A)	Dia. (B) or (BxO)	Length (C)	Overall Length (D)		Inlet (F)	Outlet (G)	Loc. (H)	Length (I)	Length (J)	End Center (K)	End Center (L)	Inlet	Outlet	
M120235	3	5.00 127	10 x15 254 x 381	35.87 911	39.87 1013	5.00 127		3.12 79	6.13 153	8.00 203				6:00	9:00	39 18
M120365	2	5.00 127	10 x15 254 x 381	36.00 914	42.50 1080	5.00 127	3.12 79	3.12 79			3.25 83			6:00	12:00	44 20
M120366	4	5.00 127	10 x15 254 x 381	36.00 914	39.25 997	5.00 127	3.12 79				3.12 79	28.38 721	9.50 241	3:00	9:00	48 22
M120367	4	4.00 102	10 x15 254 x 381	30.38 772	34.00 864	4.00 102	4.25 108				3.50 89	22.88 581	10.50 267	3:00	9:00	32 15
M120382	3	4.00 102	10 x15 254 x 381	15.00 381	21.57 548	3.85 OD 98 OD		4.40 112	3.25 83	10.80 274				9:00	9:00	18 8
M120418	6	5.00 127	10 x15 254 x 381	28.00 711	28.25 718	5.00 127			5.00 127	8.00 203		5.00 127	8.00 203	6:00	12:00	27 12
M120448	2	5.00 127	10 x15 254 x 381	44.00 1118	50.00 1270	5.00 127	3.59 91	3.59 91			3.00 76			3:00	9:00	50 23
M120450	5	5.00 127	10 x15 254 x 381	44.00 1118	47.38 1203	5.00 127	3.59 91	3.59 91			3.25 83			3:00	9:00	46 21
M120566	3	4.00 102	10 x15 254 x 381	21.00 533	25.25 641	5.00 127		4.25 108	3.13 80	10.80 274				3:00	3:00	25 11
M120598	3	4.00 102	11.84 301	32.13 816	35.50 902	5.00 127			4.50 114	11.02 280				6:00		30 14
M120713	5	4.00 102	10 x15 254 x 381	27.00 686	31.13 791	5.00 127	4.40 112	4.25 108			4.00 102			3:00	9:00	31 14
M120747 ⁸	1	5.00 127	11.84 301	25.75 654	34.00 864	5.00 127					4.12 105					26.7 12
M120748 ⁸	2	5.00 127	11.84 301	25.75 654	34.00 864	5.00 127	2.81 71	2.81 71			4.12 105			6:00	12:00	26.7 12
M120749 ⁹	3/4	5.00 127	11.84 301	25.75 654	31.69 805	5.00 127			4.88 124	8.75 222				6:00		27.5 12.5
M120750 ⁸	5	5.00 127	11.84 301	25.75 654	31.69 805	5.00 127	2.81 71	2.81 71			4.12 105			6:00	12:00	28.7 13
M120751 ⁸	6	5.00 127	11.84 301	25.50 648	29.14 740	5.00 127			4.75 121	8.75 222		4.75 121	8.75 222	6:00	12:00	26.4 12
M122300	2	6.00 152	10 x15 254 x 381	31.75 806	42.50 1080	6.00 152	3.59 91	3.59 91			5.38 137			3:00	9:00	43 20
M140048	2	6.00 152	12 x18 305 x 457	30.00 762	38.00 965	6.00 152	4.50 114	4.50 114			4.00 102			3:00	9:00	50 23
M170101	2	6.00 152	14 x21 357 x 533	35.00 889	47.00 1194	6.00 152	5.25 133	5.25 133			6.00 152			3:00	9:00	89 40
M190002	2	8.00 203	16 x24 406 x 607	45.00 1143	57.00 1448	8.00 203	6.00 152	6.00 152			6.00 152			3:00	3:00	124 56

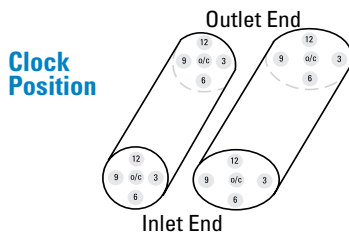

Footnotes

- 1 Wrapped muffler (reduces noise and surface temperature)
- 2 Stainless Steel
- 3 Silent Partner™ Muffler -Aluminized
- 4 Silent Partner™ Muffler -Stainless Steel
- 5 Resonator
- 6 Band clamp on inlet tube
- 7 Face flange on inlet
- 8 Made for off-road use
- 9 Made for off-road use, flows in either direction

Style 1 - End Inlet /End Outlet /On Center

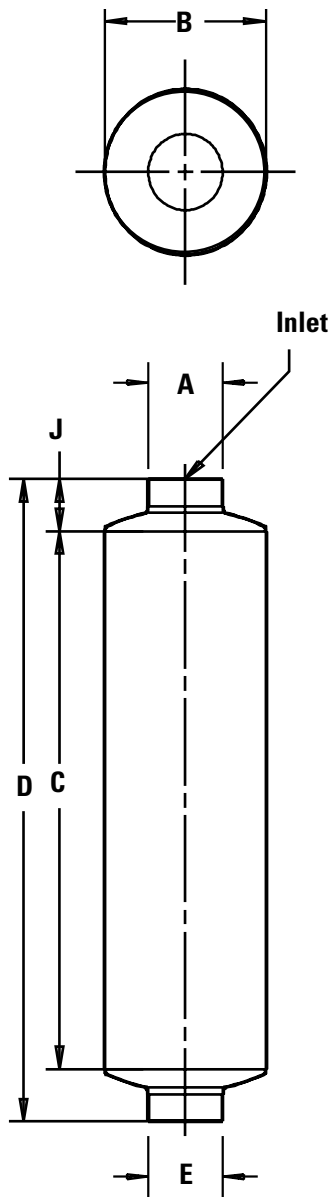

Part Number	Muffler Style	Body				Outlet I.D. (E)	Inlet Tube Length (J)	Wgt lbs. kg
		Inlet I.D. (A)	Dia. (B) or (BxO)	Length (C)	Overall Length (D)			
M060247	1	2 NPT	6.00 152	14.50 368	20.00 508	2 NPT	2.75 70	7 3
M060005	1	2.5 NPT	6.00 152	15.00 381	18.12 460	2.5 NPT	1.56 40	9 4
M070008	1	3 NPT	7.00 178	14.00 356	19.75 502	3 NPT	2.38 60	13 6
M070050	1	3.5 NPT	7.00 178	18.38 467	25.62 651	3.5 NPT	3.00 76	18 8
M090009	1	4 NPT	9.00 229	20.00 508	26.00 660	4 NPT	3.00 76	23 10
M045237	1	2.00	4.38 111	12.50 318	17.00 432	2.10 OD 53 OD	2.50 64	4 2
M060479 ⁸	1	2.00	6.00 152	15.75 400	21.00 533	2.00 51	2.62 67	7.6 3.4
M065071	1	2.50	6.62 168	15.00 381	22.00 559	2.60 OD 66 OD	3.50 89	7 3
M065138 ⁸	1	2.50	6.62 168	17.75 451	24.00 610	2.50 64	3.12 79	9.8 4.5
M085293	1	2.89 ⁷	8.50 216	31.75 806	46.25 1175	3.16 OD 80 OD		28 12
M085407 ⁸	1	3.00	8.50 216	19.75 502	26.50 673	3.00 76	3.38 86	15.2 7
M080018	1	3.00	8.00 203	12.18 309	17.00 432	3.13 OD 80 OD	1.38 35	10 5
M111029	1	3.00	11.00 279	36.00 914	42.00 1067	4.00 102	3.00 76	34 15
M070028	1	3.50	7.00 178	14.00 356	19.75 502	3.50 89	2.38 60	10 5
M090146	1	3.50	9.00 229	44.50 1130	51.00 1295	3.50 89	3.00 76	32 15
M091046 ⁸	1	3.50	9.00 229	21.75 552	29.00 737	3.50 89	3.62 89	15.8 7.2
M085171	1	4.00	8.50 216	34.37 873	40.00 1016	4.00 102	2.50 64	21 10
M085421	1	4.00	8.50 216	34.37 873	40.00 1016	4.00 102	2.50 64	21 10
M090095	1	4.00 ⁷	9.00 229	29.31 744	73.00 1854	4 OD 102 OD		33 15
M090362 ⁵	1	4.00	9.00 229	10.00 254	16.50 419	4.00 102	3.00 76	9 4
M090544	1	4.00	9.00 229	44.44 1129	51.00 1295	4.00 102	3.00 76	27 12
M090594	1	4.00	9.00 229	20.00 508	26.50 673	4.00 102	3.00 76	14 6
M090781	1	4.00	9.00 229	44.44 1129	51.00 1295	5.00 127	3.00 76	30 14
M100464 ¹	1	4.00	10.33 262	44.50 1130	51.00 1295	4.00 102	3.00 76	52 24
M100466	1	4.00	10.00 254	44.44 1129	51.00 1295	4.00 102	3.00 76	27 12
M100695	1	4.00	10.00 254	44.44 1129	51.00 1295	5.00 127	3.00 76	30 14
M101167 ⁸	1	4.00	10.00 254	23.75 603	32.00 813	4.00 102	4.12 105	19.3 8.8

Style 1 - End Inlet /End Outlet /On Center

MUFFLER SPECS

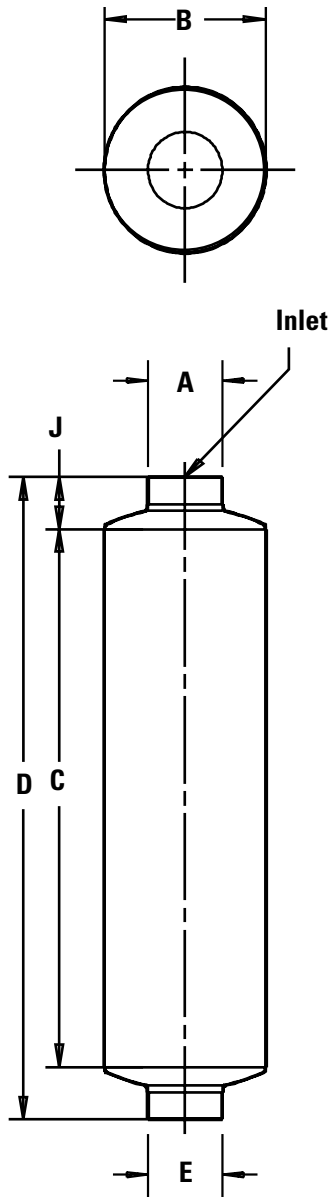

Part Number	Muffler Style	Body				Outlet I.D. (E)	Inlet Tube Length (J)	Wgt lbs. / kg
		Inlet I.D. (A)	Dia. (B) or (BxO)	Length (C)	Overall Length (D)			
M090072 ⁵	1	5.00 127	9.00 229	10.00 254	16.50 419	5.00 127	3.00 76	9 4
M090074	1	5.00 127	9.00 229	44.44 1129	51.00 1295	5.00 127	3.00 76	29 13
M090535	1	5.00 127	9.00 229	44.44 1129	51.00 1295	5.00 127	3.00 76	30 14
M090595	1	5.00 127	9.00 229	20.00 508	26.50 673	5.00 127	3.00 76	15 7
M100463	1	5.00 127	10.00 254	44.44 1129	51.00 1295	5.00 127	3.00 76	31 14
M100465	1	5.00 127	10.00 254	44.44 1129	51.00 1295	5.00 127	3.00 76	28 13
M100580	1	5.00 127	10.00 254	44.44 1129	51.00 1295	5.00 127	3.00 76	29 13
M100582	1	5.00 127	10.00 254	44.44 1129	51.00 1295	5.00 127	3.00 76	31 14
M100807	1	5.00 127	10.00 254	59.94 1522	66.50 1689	5.00 127	3.00 76	48 22
M100944	1	5.00 127	10.00 254	44.44 1129	51.00 1295	5.00 127	3.00 76	32 15
M101158 ⁴	1	5.00 127	10.00 254	44.44 1129	51.00 1295	5.00 127	3.00 76	43 20
M101159 ⁴	1	5.00 127	10.00 254	44.44 1129	51.00 1295	5.00 127	3.00 76	43 20
M101181 ³	1	5.00 127	10.00 254	44.44 1129	51.00 1295	5.00 127	3.00 76	43 20
M101182 ³	1	5.00 127	10.00 254	44.44 1129	51.00 1295	5.00 127	3.00 76	43 20
M101263	1	5.00 127	10.00 254	44.44 1129	53.00 1346	5.00 127	3.00 76	31 14
M110849	1	5.00 127	11.00 279	50.50 1283	57.00 1448	5.00 127	3.00 76	48 22
M120747 ⁸	1	5.00 127	11.84 301	25.75 654	34.00 864	5.00 127	4.12 105	26.7 12

Style 2 and 2A on pages 70 and 71

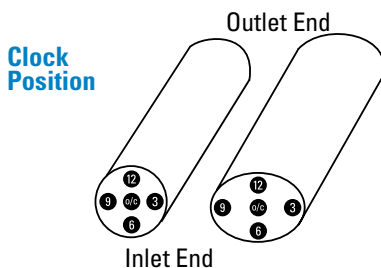

Footnotes

- 1 Wrapped muffler (reduces noise and surface temperature)
- 2 Stainless Steel
- 3 Silent Partner™ Muffler -Aluminized
- 4 Silent Partner™ Muffler -Stainless Steel
- 5 Resonator
- 6 Band clamp on inlet tube
- 7 Face flange on inlet
- 8 Made for off-road use
- 9 Made for off-road use, flows in either direction

Style 3 - Side Inlet /End Outlet

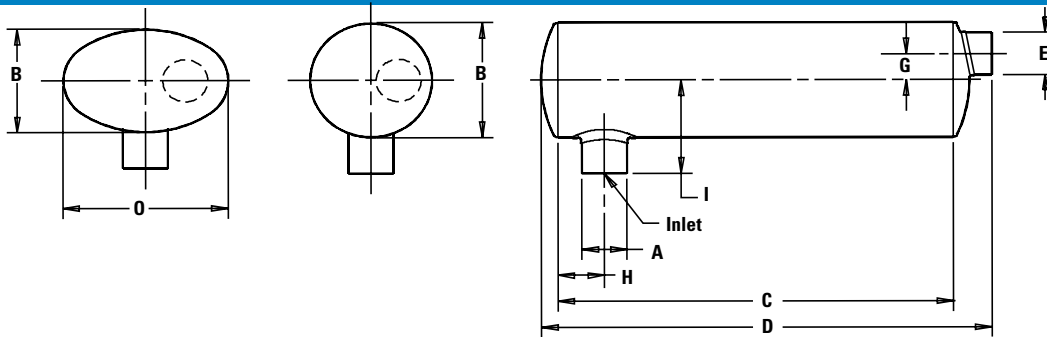

Part Number	Muffler Style	Body				Outlet I.D. (E)	Offset		Inlet Tube			Outlet Tube from End Center		Clock Position		Wgt lbs. kg
		Inlet I.D. (A)	Dia. (B) or (BxO)	Length (C)	Overall Length (D)		Inlet (F)	Outlet (G)	Loc. (H)	Length (I)	Length (J)	K	L	Inlet	Outlet	
M045193	3	1.68 43	4.38 111	13.78 350	15.78 401	1.64 42		2.75 70	4.00 102					12:00		4 2
M060158	3	2.00 51	6.00 152	18.81 478	21.50 546	2.00 51	1.50 38	3.50 89	5.00 127					3:00	6:00	9 4
M060481 ⁹	3/4	2.00 51	6.00 152	15.75 400	19.25 489	2.00 51		1.88 48	5.00 127					6:00		7.6 3.4
M065044	3	2.50 64	6.62 168	20.89 531	23.50 597	2.50 64	1.62 41	3.50 89	6.00 152					6:00	9:00	12 5
M065140 ⁹	3/4	2.50 64	6.62 168	17.75 451	22.04 560	2.50 64		2.38 60	5.75 146					6:00		10 4.5
M085084	3	3.50 89	8.50 216	27.00 686	29.50 749	3.00 76	2.00 51	4.50 114	7.25 184					3:00	6:00	20 9
M085090	3	3.02 77	8.50 216	26.25 667	29.50 749	3.00 76	2.00 51	3.50 89	6.75 171					3:00	6:00	20 9
M085226 ¹	3	3.00 76	8.80 224	27.12 689	29.56 751	3.00 76	2.00 51	4.56 116	6.75 171					3:00	6:00	28 13
M085409 ⁹	3/4	3.00 76	8.50 216	19.75 502	24.27 616	3.00 76		2.88 73	6.50 165					6:00		15.4 7
M090301	3	3.50 89	8.3 x 11.5 211 x 292	26.13 664	29.25 743	3.50 89	2.50 64	3.25 83	7.00 178					6:00	9:00	23 10
M090823	3	4.00 102	9.00 229	44.50 1130	48.00 1219	5.00 127		3.81 97	6.69 170					6:00		30 13
M091048 ⁹	3/4	3.50 89	9.00 229	21.75 552	26.38 670	3.50 89		3.38 86	7.25 184					6:00		15.9 7.2
M100146	3	4.00 102	10.00 254	28.00 711	32.00 813	4.00 102	2.44 62	4.50 114	8.00 203					6:00	9:00	27 12
M100213	3	5.00 127	10.00 254	44.50 1130	48.00 1219	5.00 127		5.50 140	7.50 191					6:00		33 15
M101169 ⁹	3/4	4.00 102	10.00 254	23.75 603	29.24 743	4.00 102		3.88 99	8.00 203					6:00		19.8 9
M110479	3	4.00 102	11.00 279	36.00 914	39.00 991	4.00 102	2.50 64	4.25 108	8.64 219					6:00	3:00	31 14
M110674 ⁹	3	4.00 102	11.00 279	33.00 838	36.00 914	4.00 102		3.75 95	8.64 219					6:00		27 12
M111024	3	4.00 102	11.00 279	36.00 914	44.59 1133	Down Spout		3.75 95	8.64 219					12:00	6:00	34 15
M120235	3	5.00 127	10 x 15 254 x 381	35.87 911	39.87 1013	5.00 127	3.12 79	6.13 153	8.00 203					6:00	9:00	39 18
M120382	3	4.00 102	10 x 15 254 x 381	15.00 381	21.57 548	3.85 OD 98 OD	4.40 112	3.25 83	10.80 274					9:00	9:00	18 8
M120566	3	4.00 102	10 x 15 254 x 381	21.00 533	25.25 641	5.00 127	4.25 108	3.13 80	10.80 274					3:00	3:00	25 11
M120598	3	4.00 102	11.84 301	32.13 816	35.50 902	5.00 127		4.50 114	11.02 280					6:00		30 14
M120749 ⁹	3/4	5.00 127	11.84 301	25.75 654	31.69 805	5.00 127		4.88 124	8.75 222					6:00		27.5 12.5

Muffler Specifications by Style & Inlet Size

MUFFLER SPECS

Style 2 - End Inlet /End Outlet /Offset and Style 2A - Dual End Inlet /End Outlet

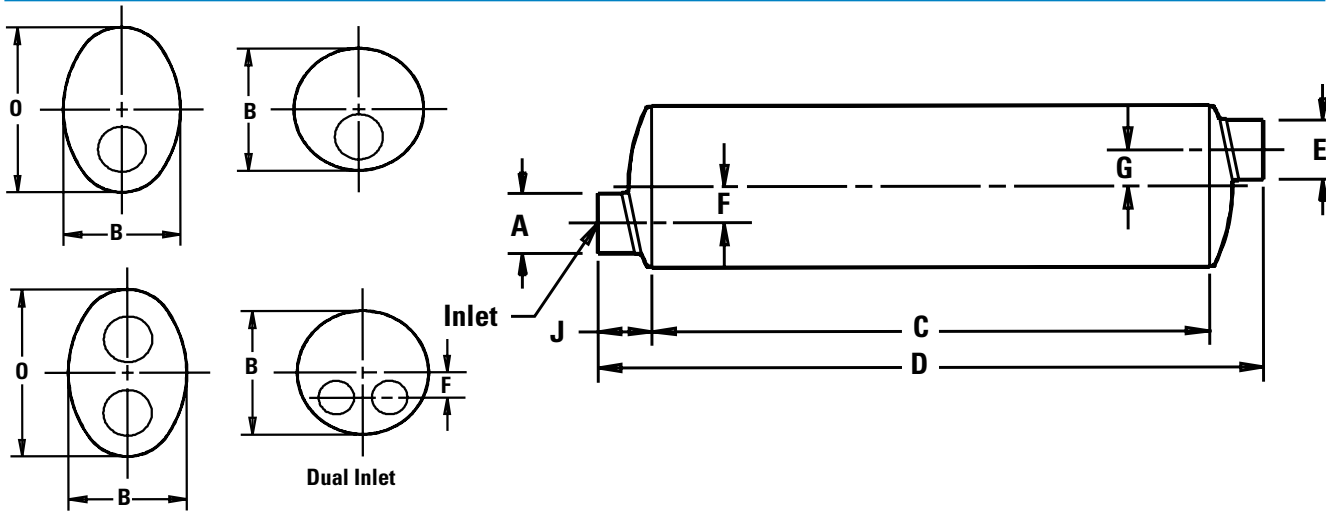

Part Number	Muffler Style	Body				Outlet I.D. (E)	Offset		Inlet Tube			Outlet Tube from End Center (K)	Clock Position Inlet	Clock Position Outlet	Wgt lbs. kg
		Inlet I.D. (A)	Dia. (B) or (BxO)	Length (C)	Overall Length (D)		Inlet (F)	Outlet (G)	Loc. (H)	Length (I)	Length (J)				
M060055	2	2.00 51	6.00 152	16.90 429	21.90 556	2.00 51	1.50 38	1.50 38			2.50 64		6:00 12:00	7 3	
M060232	2	2.00 51	6.00 152	24.00 610	29.00 737	2.00 51	1.50 38	1.50 38			2.50 64		6:00 12:00	9 4	
M060480 ⁸	2	2.00 51	6.00 152	15.75 400	21.00 533	2.00 51	1.50 38	1.50 38			2.62 67		6:00 12:00	7.6 3.4	
M065034	2	2.50 64	6.62 168	18.56 471	23.00 584	2.50 64	1.62 41	1.62 41			1.50 38		6:00 12:00	9 4	
M065139 ⁸	2	2.50 64	6.62 168	17.75 451	24.00 610	2.50 64	1.62 41	1.62 41			3.12 79		6:00 12:00	9.8 4.5	
M085172	2A	2.50 (2) 64 (2)	8.50 216	30.00 762	39.00 991	2.75 70	1.62 (2) 41 (2)	2.00 51			2.50 (2) 64 (2)		6:00(2) 6:00	24 11	
M085189 ²	2A	2.50 (2) 64 (2)	8.50 216	31.25 794	36.25 921	3.00 76	1.62 (2) 41 (2)	2.00 51			2.50 (2) 64 (2)		6:00 (2) 12:00	23 10	
M085267 ^{1,2}	2A	2.50 (2) ⁷ 64 (2) ⁷	8.75 222	30.12 765	38.97 990	3 OD 76 OD	1.62 (2) 41 (2)	2.00 51			5.72/3.22 146/82		6:00 (2) 12:00	32 15	
M090563	2A	2.75 (2) 70 (2)	8.2 x 11.5 208 x 292	27.00 686	32.75 832	4.00 102	0.15/4.00 9/102	2.50 64			2.63 (2) 67 (2)		9:00-3:00 3:00	22 10	
M085023	2	3.00 76	8.50 216	31.25 794	36.25 921	3.00 76	2.00 51	2.00 51			2.50 64		6:00 12:00	19 9	
M085056	2	3.00 76	8.50 216	20.50 521	25.00 635	3.00 76	2.00 51	2.00 51			1.50 38		6:00 12:00	14 6	
M085078	2	3.00 76	8.50 216	27.50 699	32.00 813	3.00 76	2.00 51	2.00 51			1.50 38		6:00 12:00	20 9	
M085080	2	3.00 76	8.50 216	27.75 705	33.75 857	3.00 76	2.00 51	2.00 51			3.50 89		6:00 6:00	20 9	
M090159 ¹	2	3.00 76	8.5 x 11.8 216 x 300	26.00 660	33.75 857	3.00 76	2.50 64	2.50 64			3.88 99		3:00 3:00	29 13	
M090170	2	3.00 76	8.3 x 11.5 211 x 292	26.00 660	33.75 857	3.00 76	2.50 64	2.50 64			3.88 99		3:00 3:00	20 9	
M085408 ⁸	2	3.00 76	8.50 216	19.75 502	26.50 673	3.00 76	2.00 51	2.00 51			3.38 86		6:00 12:00	15.2 7	
M085008	2	3.50 89	8.50 216	38.00 965	43.00 1092	3.00 76	1.75 44	2.00 51			2.50 64		6:00 12:00	23 10	
M090158	2	3.50 89	8.3 x 11.5 211 x 292	26.00 660	32.25 819	3.50 89	2.50 64	2.50 64			3.12 79		3:00 9:00	24 11	
M090210 ¹	2	3.50 89	8.5 x 11.8 216 x 300	26.00 660	32.25 819	3.50 89	2.50 64	2.50 64			3.12 79		3:00 9:00	34 15	

Part Number	Muffler Style	----- Body -----				Outlet I.D. (E)	---- Offset ----		----- Inlet Tube -----			Outlet Tube from End Center (K) (L)		Clock Position Inlet Outlet	Wgt lbs. kg
		Inlet I.D. (A)	Dia. (B) or (BxO)	Length (C)	Overall Length (D)		Inlet (F)	Outlet (G)	Loc. (H)	Length (I)	Length (J)				
M090520	2	3.50 89	8.2 x11.5 208 x 292	26.00 660	32.25 819	4.00 102	2.50 64	2.50 64			3.12 79		3:00 9:00	21 10	
M090680	2	3.50 89	8.2 x11.5 208 x 292	30.00 762	36.25 921	4.00 102	2.50 64	2.50 64			3.12 79		3:00 9:00	25 11	
M091047 ⁸	2	3.50 89	9.00 229	21.75 552	29.00 737	3.50 89	2.10 53	2.10 53			3.62 89		6:00 12:00	15.8 7.2	
M090280	2	4.00 102	8.2 x11.5 208 x 292	26.00 660	32.25 819	4.00 102	2.50 64	2.50 64			3.12 79		3:00 9:00	22 10	
M090534	2	4.00 102	8.2 x11.5 208 x 292	26.00 660	33.75 857	4.00 102	2.50 64	2.50 64			3.88 99		3:00 9:00	26 12	
M090538	2	4.00 102	8.2 x11.5 208 x 292	26.00 660	32.25 819	3.50 89	2.50 64	2.50 64			3.12 79		3:00 12:00	26 12	
M100043	2	4.00 102	10.00 254	35.38 899	41.75 1060	4.00 102	2.44 62	2.44 62			2.88 73		6:00 12:00	32 15	
M100048	2	4.00 102	10.00 254	27.12 689	33.50 851	4.00 102	2.44 62	2.44 62			2.88 73		6:00 12:00	27 12	
M101168 ⁸	2	4.00 102	10.00 254	23.75 603	32.00 813	4.00 102	2.44 62	2.44 62			4.12 105		6:00 12:00	19.3 8.8	
M110012	2	4.00 102	11.00 279	30.00 762	36.00 914	4.00 102	2.50 64	2.50 64			3.00 76		6:00 12:00	26 12	
M110028	2	4.00 102	11.12 282	34.75 883	42.50 1080	4.00 102	3.12 79	3.12 79			4.25 108		6:00 12:00	41 19	
M110189	2	4.00 102	11.00 279	36.00 914	41.25 1048	4.00 102	2.50 64	2.50 64			2.63 67		6:00 12:00	34 15	
M111028	2	4 OD 102 OD	11.00 279	36.00 914	44.00 1118	5.00 127		2.50 64			5.00 127		12:00	36 16	
M120100	2	4.00 102	10 x15 254 x 381	26.00 660	32.50 826	4.00 102	4.25 108	4.25 108			3.25 83		3:00 9:00	30 14	
M120197 ¹	2	4.00 102	10.3 x15.3 261 x 389	36.00 914	42.00 1067	4.00 102	4.25 108	0.50 13			3.00 76		3:00 9:00	58 26	
M110077	2	5.00 127	11.00 279	44.00 1118	50.00 1270	5.00 127	2.50 64	2.50 64			3.00 76		6:00 12:00	44 20	
M120108	2	5.00 127	10 x15 254 x 381	26.00 660	32.50 826	5.00 127	3.12 79	3.12 79			3.25 83		3:00 9:00	34 15	
M120225	2	5.00 127	10 x15 254 x 381	26.00 660	32.50 826	5.00 127	3.12 79	3.12 79			3.25 86		3:00 9:00	31 14	
M120365	2	5.00 127	10 x15 254 x 381	36.00 914	42.50 1080	5.00 127	3.12 79	3.12 79			3.25 83		6:00 12:00	44 20	
M120448	2	5.00 127	10 x15 254 x 381	44.00 1118	50.00 1270	5.00 127	3.59 91	3.59 91			3.00 76		3:00 9:00	50 23	
M120748 ⁸	2	5.00 127	11.84 301	25.75 654	34.00 864	5.00 127	2.81 71	2.81 71			4.12 105		6:00 12:00	26.7 12	
M122300	2	6.00 152	10 x15 254 x 381	31.75 806	42.50 1080	6.00 152	3.59 91	3.59 91			5.38 137		3:00 9:00	43 20	
M140048	2	6.00 152	12 x18 305 x 457	30.00 762	38.00 965	6.00 152	4.50 114	4.50 114			4.00 102		3:00 9:00	50 23	
M170101	2	6.00 152	14 x21 357 x 533	35.00 889	47.00 1194	6.00 152	5.25 133	5.25 133			6.00 152		3:00 9:00	89 40	
M190002	2	8.00 203	16 x24 406 x 607	45.00 1143	57.00 1448	8.00 203	6.00 152	6.00 152			6.00 152		3:00 3:00	124 56	

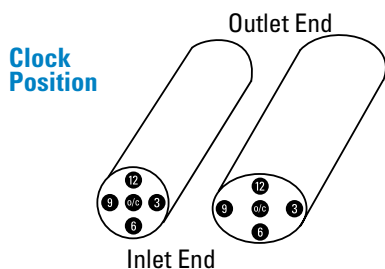

Footnotes

- 1 Wrapped muffler (reduces noise and surface temperature)
- 2 Stainless Steel
- 3 Silent Partner™ Muffler -Aluminized
- 4 Silent Partner™ Muffler -Stainless Steel
- 5 Resonator
- 6 Band clamp on inlet tube
- 7 Face flange on inlet
- 8 Made for off-road use
- 9 Made for off-road use, flows in either direction

Muffler Specifications by Style & Inlet Size

MUFFLER SPECS

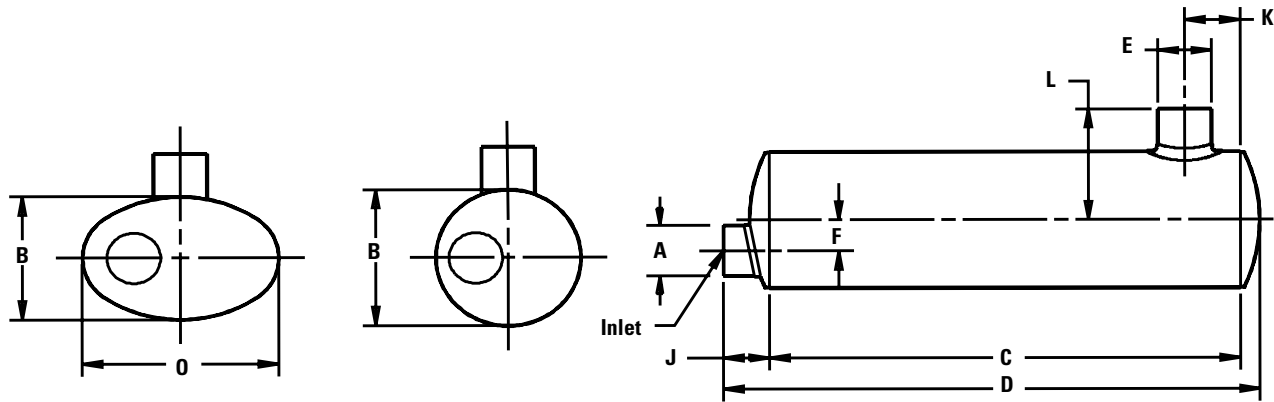
Style 4 - End Inlet /Side Outlet



Part Number	Muffler Style	Body				Outlet I.D. (E)	Offset		Inlet Tube			Outlet Tube from End Center		Clock Position		Wgt lbs. kg
		Inlet I.D. (A)	Dia. (B) or (BxO)	Length (C)	Overall Length (D)		Inlet (F)	Outlet (G)	Loc. (H)	Length (I)	Length (J)	(K)	(L)	Inlet	Outlet	
M060481 ⁹	3/4	2.00 51	6.00 152	15.75 400	19.25 489	2.00 51			1.88 48	5.00 127				6:00		7.6 3.4
M065140 ⁹	3/4	2.50 64	6.62 168	17.75 451	22.04 560	2.50 64			2.38 60	5.75 146				6:00		10 4.5
M085206	4	3.00 76	8.50 216	26.25 667	29.50 749	3.00 76	2.00 51				3.25 83	3.50 89	6.75 171	6:00	9:00	20 9
M085409 ⁹	3/4	3.00 76	8.50 216	19.75 502	24.27 616	3.00 76			2.88 73	6.50 165				6:00		15.4 7
M090547	4	3.50 89	8.2 x 11.5 208 x 292	32.56 827	35.16 893	4.00 102	2.50 64				2.60 66	20.48 520	6.00 152	9:00	7:00	22 10
M090548	4	3.50 89	8.2 x 11.5 208 x 292	32.56 827	35.16 893	4 OD 102 OD	2.50 64				2.60 66	20.48 520	8.70 221	3:00	7:30	21 10
M091048 ⁹	3/4	3.50 89	9.00 229	21.75 552	26.38 670	3.50 89			3.38 86	7.25 184				6:00		15.9 7.2
M100052	4	4.00 102	10.00 254	27.75 705	30.75 781	4.00 102	2.44 62				3.00 76	24.25 616	8.75 222	6:00	2:00	25 11
M101169 ⁹	3/4	4.00 102	10.00 254	23.75 603	29.24 743	4.00 102			3.88 99	8.00 203				6:00		19.8 9
M110112	4	4.00 102	11.00 279	36.00 914	39.00 991	4.00 102	2.50 64				3.00 76	15.97 406	8.64 219	6:00	9:00	29 13
M110148	4	4.00 102	11.00 279	36.00 914	39.00 991	4.00 102	2.50 64				3.00 76	17.25 438	8.64 219	6:00	12:00	29 13
M120367	4	4.00 102	10 x 15 254 x 381	30.38 772	34.00 864	4.00 102	4.25 108				3.50 89	22.88 581	10.50 267	3:00	9:00	32 15
M110311	4	4.00 OD 102	11.00 279	36.00 914	41.00 1041	4.00 102	2.50 64				5.00 127	27.10 688	8.64 219	6:00	12:00	27 12
M111025	4	4 OD 102 OD	11.00 279	36.00 914	41.00 1041	4 OD 102 OD					5.00 127	19.66 499	10.50 267		6:00	27 12
M110014	4	5.00 127	11.00 279	46.00 1168	51.75 1314	5.00 127	2.50 64				4.25 108	38.50 978	8.50 216	6:00	12:00	45 20
M120366	4	5.00 127	10 x 15 254 x 381	36.00 914	39.25 997	5.00 127	3.12 79				3.12 79	28.38 721	9.50 241	3:00	9:00	48 22
M120749 ⁹	3/4	5.00 127	11.84 301	25.75 654	31.69 805	5.00 127			4.88 124	8.75 222				6:00		27.5 12.5

Style 5 - Inlet & Outlet on Same End

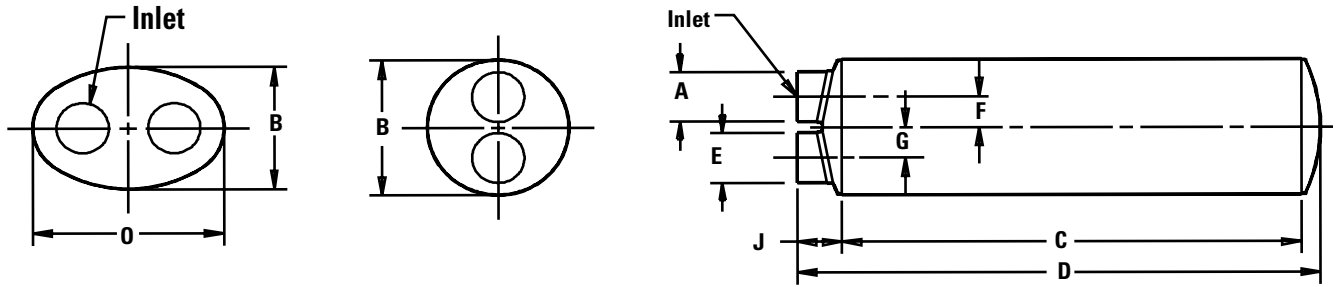

Part Number	Muffler Style	Body				Outlet I.D. (E)	Offset		Inlet Tube			Outlet Tube from End Center		Clock Position		Wgt lbs. / kg
		Inlet I.D. (A)	Dia. (B) or (BxO)	Length (C)	Overall Length (D)		Inlet (F)	Outlet (G)	Loc. (H)	Length (i)	Length (j)	End Center (K)	(L)	inlet	Outlet	
M060250	5	2.00 51	6.00 152	16.90 429	19.40 493	2.00 51	1.50 38	1.50 38			2.50 64			6:00	12:00	8 4
M060482 ⁸	5	2.00 51	6.00 152	15.75 400	19.25 489	2.00 51	1.50 38	1.50 38			2.62 67					8.4 3.8
M065073	5	2.50 64	6.62 168	20.00 508	21.50 546	2.50 64	1.62 41	1.62 41			1.50 38			6:00	12:00	10 5
M065141 ⁸	5	2.50 64	6.62 168	17.75 451	22.04 560	2.50 64	1.63 41	1.63 41			3.12 79			6:00	12:00	10.6 4.8
M085207	5	3.00 76	8.50 216	22.00 559	23.50 597	3.00 76	2.00 51	2.00 51			1.50 38			6:00	12:00	16 7
M085410 ⁸	5	3.00 76	8.50 216	19.75 502	24.27 616	3.00 76	2.00 51	2.00 51			3.38 86			6:00	12:00	17 7.7
M091049 ⁸	5	3.50 89	9.00 229	21.75 552	26.44 672	3.50 89	2.10 53	2.10 53			3.62 89			6:00	12:00	17.3 7.9
M100049	5	4.00 102	10.00 254	27.75 705	30.62 778	4.00 102	2.44 62	2.44 62			2.88 73			12:00	6:00	23 10
M101170 ⁸	5	4.00 102	10.00 254	23.75 603	29.24 743	4.00 102	2.44 62	2.44 62			4.12 105			6:00	12:00	22 10
M120154	5	4.00 102	10 x15 254 x 381	26.00 660	28.38 721	4.00 102	4.25 108	4.25 108			2.25 57			3:00	9:00	31 14
M120713	5	4.00 102	10 x15 254 x 381	27.00 686	31.13 791	5.00 127	4.40 112	4.25 108			4.00 102			3:00	9:00	31 14
M120131	5	5.00 127	10 x15 254 x 381	26.00 660	29.39 747	5.00 127	3.12 79	3.12 79			3.25 83			3:00	9:00	32 15
M120176	5	5.00 127	10 x15 254 x 381	26.25 667	29.38 746	5.00 127	3.12 79	3.12 79			3.00 76			3:00	9:00	29 13
M120189	5	5.00 127	10 x15 254 x 381	33.38 848	39.50 1003	5.00 127	3.59 91	3.59 91			4.44 113			3:00	9:00	46 21
M120450	5	5.00 127	10 x15 254 x 381	44.00 1118	47.38 1203	5.00 127	3.59 91	3.59 91			3.25 83			3:00	9:00	46 21
M120750 ⁸	5	5.00 127	11.84 301	25.75 654	31.69 805	5.00 127	2.81 71	2.81 71			4.12 105			6:00	12:00	28.7 13

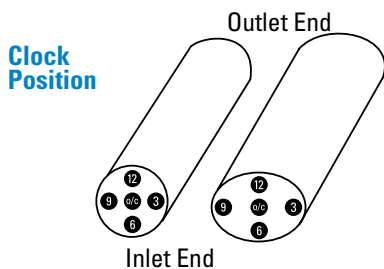

Footnotes

- 1 Wrapped muffler (reduces noise and surface temperature)
- 2 Stainless Steel
- 3 Silent Partner™ Muffler -Aluminized
- 4 Silent Partner™ Muffler -Stainless Steel
- 5 Resonator
- 6 Band clamp on inlet tube
- 7 Face flange on inlet
- 8 Made for off-road use
- 9 Made for off-road use, flows in either direction

Muffler Specifications by Style & Inlet Size

MUFFLER SPECS

Style 6 - Side Inlet /Side Outlet

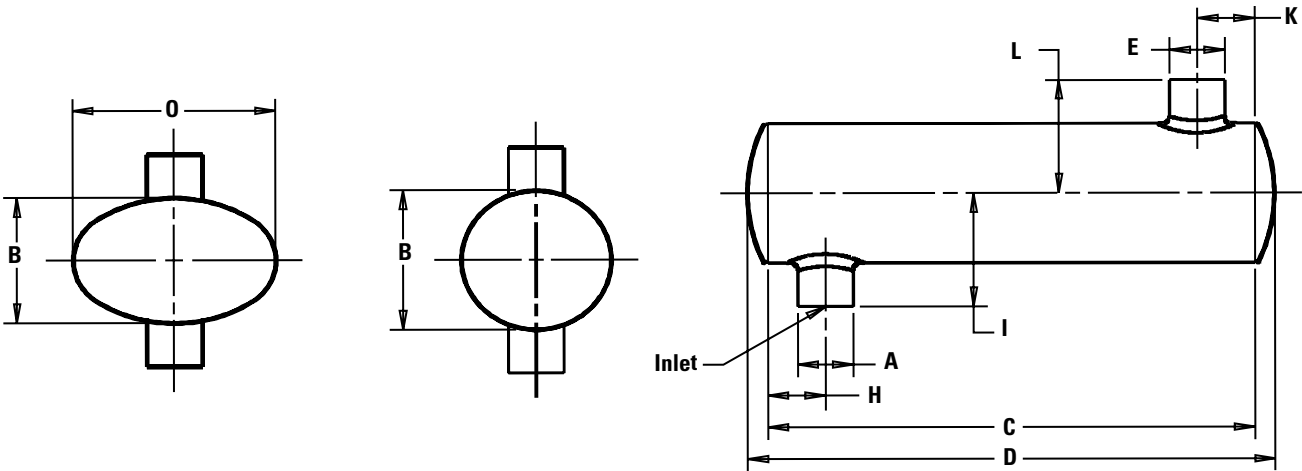

Part Number	Muffler Style	Body				Outlet I.D. (E)	Offset		Inlet Tube			Outlet Tube from End Center		Clock Position		Wgt lbs. kg
		Inlet I.D. (A)	Dia. (B) or (BxO)	Length (C)	Overall Length (D)		Inlet (F)	Outlet (G)	Loc. (H)	Length (I)	Length (J)	(K)	(L)	Inlet	Outlet	
M060251	6	2.00 51	6.00 152	18.81 478	18.81 478	2.00 51			3.50 89	5.00 127		3.50 89	5.00 127	6:00	12:00	8 4
M060483 ⁸	6	2.00 51	6.00 152	15.50 394	17.24 438	2.00 51			1.75 44	5.00 127		1.75 44	5.00 127	6:00	12:00	7.4 3.4
M065074	6	2.50 64	6.62 168	20.81 529	20.81 529	2.50 64			3.50 89	6.00 152		3.50 89	6.00 152	6:00	12:00	10 5
M065142 ⁸	6	2.50 64	6.62 168	17.50 444	19.84 504	2.50 64			2.50 64	5.75 146		2.25 57	5.75 146	6:00	12:00	9.4 4.2
M085208	6	3.00 76	8.50 216	27.00 686	27.00 686	3.00 76			3.50 89	6.75 171		3.50 89	6.75 171	6:00	12:00	17 8
M085284	6	3.00 76	8.50 216	27.00 686	27.00 686	3.00 76			3.50 89	6.75 171		3.50 89	6.75 171	6:00	12:00	19 9
M085411 ⁸	6	3.00 76	8.50 216	19.50 495	21.78 553	3.00 76			3.00 76	6.50 165		3.00 76	6.50 165	6:00	12:00	14.2 6.4
M090598	6	3.50 89	8.3 x 11.5 211 x 292	26.00 660	26.00 660	3.50 89			3.38 86	7.00 178		3.38 86	7.00 178	6:00	12:00	20 9
M091050 ⁸	6	3.50 89	9.00 229	21.50 546	23.64 600	3.50 89			3.25 83	7.25 184		3.25 83	7.25 184	6:00	12:00	15.1 6.9
M100572	6	4.00 102	10.12 257	28.00 711	30.62 778	4.00 102			4.50 114	8.00 203		4.50 114	8.00 203	6:00	12:00	22 10
M101171 ⁸	6	4.00 102	10.00 254	23.50 597	26.24 666	4.00 102			3.75 95	8.00 203		3.75 95	8.00 203	6:00	12:00	19.1 8.7
M111026	6	4.00 102	11.00 279	36.00 914	36.00 914	4 OD 102 OD			3.75 95	8.64 219		9.23 234	9.50 241	12:00	9:00	29 13
M120418	6	5.00 127	10 x 15 254 x 381	28.00 711	28.25 718	5.00 127			5.00 127	8.00 203		5.00 127	8.00 203	6:00	12:00	27 12
M120751 ⁸	6	5.00 127	11.84 301	25.50 648	29.14 740	5.00 127			4.75 121	8.75 222		4.75 121	8.75 222	6:00	12:00	26.4 12

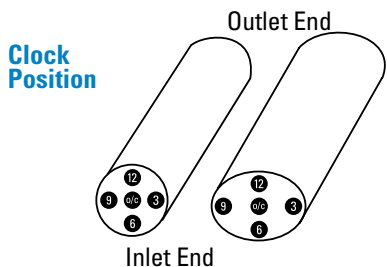

Footnotes

- 1 Wrapped muffler (reduces noise and surface temperature)
- 2 Stainless Steel
- 3 Silent Partner™ Muffler -Aluminized
- 4 Silent Partner™ Muffler -Stainless Steel
- 5 Resonator
- 6 Band clamp on inlet tube
- 7 Face flange on inlet
- 8 Made for off-road use
- 9 Made for off-road use, flows in either direction