

PRONOVOST

OWNER'S MANUAL



Bale Accumulator *(Cardinal system)*

Model PC-1836

Copyright © Les Machineries Pronovost Inc., 1994

All rights reserved.
Printed in Canada.

TABLE OF CONTENTS

Section	Item	Page
1	Introduction	5
2	Safety	6
	General Safety	6
	Safety in Operation	6
	Safety with Maintenance	6
	Safety in Transport	6
	Safety in Storage	6
3	Decals	7
	Safety Decals	7
	Maintenance Decals	7
4	Start-up	8
	Initial Installation	8
	System Verification	10
	Adjustments	11
5	Operation	13
6	Maintenance	14
7	Storage	15
8	Troubleshooting	16
9	Specifications	17
10	Parts List	18
	Electric circuit	18
	Hydraulic circuit	19
	Cylinder 25TR08	20
	Hydraulic motor DH-315	21
11	Torque Chart	22
12	Warranty	23

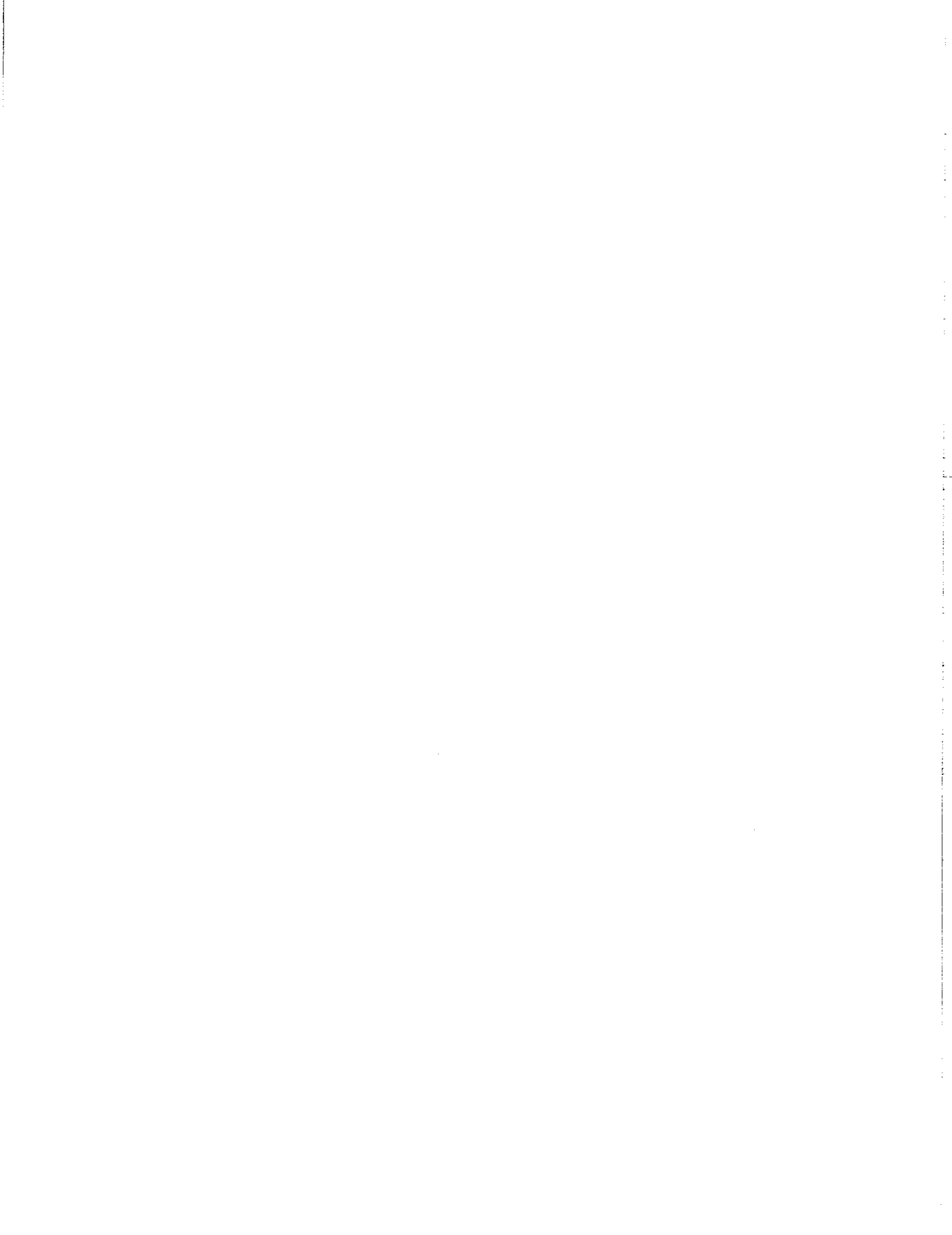

INTRODUCTION

1

CONGRATULATIONS!

Thank you for choosing PRONOVOST. We are confident this equipment will meet your requirements in terms of quality, performance and reliability.

This manual was prepared to assist you in the safe operation of your new Bale Accumulator PC-1836. It contains important information which will help you achieve excellent returns with your equipment for years to come.

Please read this manual completely before operating this equipment and keep it for future reference.

Before using the equipment, you or any other person who will be operating the accumulator must familiarize yourself with the safety recommendations and the operating instructions. Please read carefully and be sure to understand and follow all recommendations and procedures.

In this manual, the right and left sides of the equipment are identified while standing behind the machine and facing it.

If you require additional information on your Bale Accumulator, please contact your PRONOVOST Dealer.

NOW take a moment to enter the model, serial number and the date of purchase of your Bale Accumulator in the space provided below.

When ordering parts from your Dealer, please refer to these numbers for a fast and efficient service. Use PRONOVOST replacement parts.

The model and serial numbers are on the name plate shown on Figure 1.



Figure 1

MODEL: _____

SERIAL NO: _____

DATE OF PURCHASE: _____

SAFETY

GENERAL SAFETY

WHEN YOU SEE THIS SYMBOL

2



ATTENTION!

**BE ALERT
YOUR SAFETY IS INVOLVED**

This symbol «**SAFETY ALERT**» is used in this manual and on the safety decals on the Bale Accumulator. It warns you of the possibility of danger. Carefully read, understand and follow all safety recommendations before operating the equipment.

- 1) Careful operation is the best assurance against accidents. Carefully read this manual and follow all recommendations before operating this equipment. It is the owner's responsibility to make sure that anyone who will operate the Bale Accumulator will read this manual before operating the equipment.
- 2) Do not modify the equipment. Any non authorized modification may affect the efficiency and/or safety of the equipment.
- 3) Never operate the equipment with defective parts or if damaged in any way. Have it repaired before using it.
- 4) Make sure all fasteners are in place and properly secured or tightened. Refer to torque chart on page 22.
- 5) Hydraulic fluids under pressure can damage your skin. Do not use your hands to locate a leak.

SAFETY IN OPERATION

- 1) Be sure there are no obstructions around the equipment and that no one stands near the equipment when in use.
- 2) Do not operate an engine in a confined or non ventilated area.
- 3) Do not perform any adjustments, cleaning, maintenance or repairs with the engine running on the towing vehicle. Preferably remove the key from the ignition.
- 4) Be careful when backing-up, make sure you have good visibility.

SAFETY WITH MAINTENANCE

- 1) Perform maintenance according to recommendations contained in this manual.
- 2) If the Bale Accumulator is hooked up to the tractor while performing maintenance work, make sure the engine is not running and preferably remove the ignition key.

SAFETY IN TRANSPORT

- 1) On public roads, use proper safety lights and check local regulations.
- 2) Be alert while driving on the road. Never carry passengers.
- 3) Always travel at safe operating speed following regulations and common sense. The road speed should be such as to maintain full control over steering and braking.

SAFETY IN STORAGE

- 1) Provide adequate supports to prevent any accidental movement of the Bale Accumulator.

DECALS

SAFETY DECALS

The safety decals are affixed wherever special safety precautions are indicated. Locate them on the equipment and read them carefully. If a decal is damaged, lost or illegible, install a new one. The following photos indicate where each one must be installed.

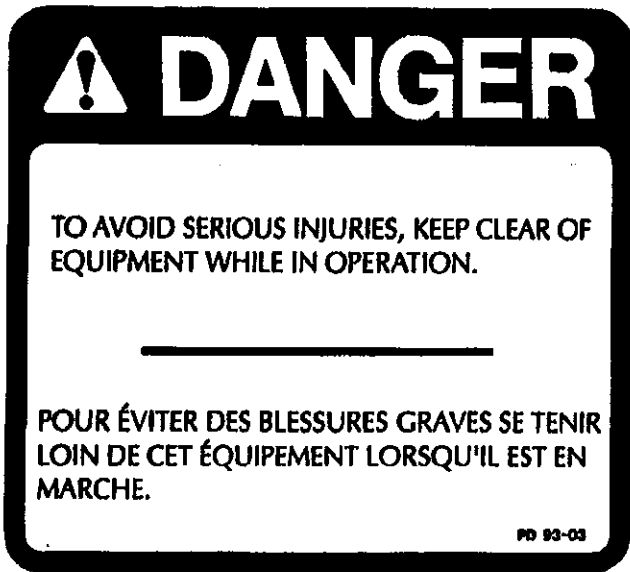

Figure 2
Decal A

Part no.: A101



Figure 3

MAINTENANCE DECALS

The maintenance decals indicate the points requiring lubrication. Refer to maintenance section for more details.

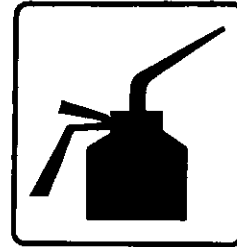

Figure 4

Part no.: A 105

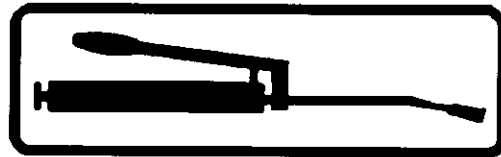

Figure 5

Part no.: A 106

3

START-UP

4



Figure 6

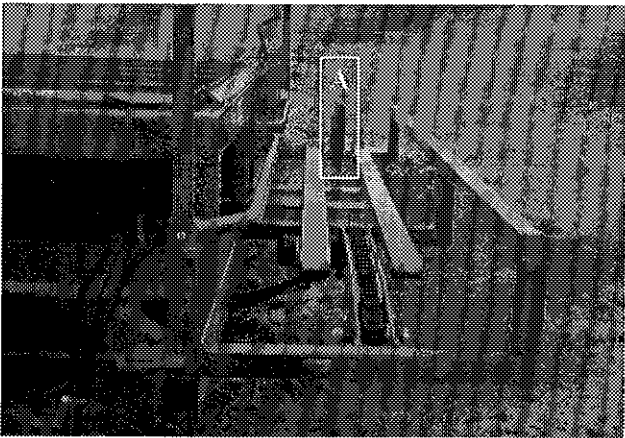

Figure 7

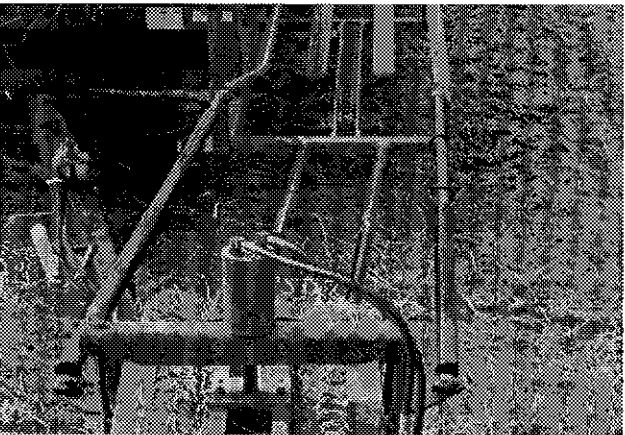

Figure 8

INITIAL INSTALLATION

- 1) Should there be a bale discharger or kicker on the press, it must be removed.
- 2) Install mounting frame and brackets assembly on the discharge end of the press. (Figure 6)
- 3) Install the elevator section as shown (Figure 7), and lock it in position with the pins provided. Hook-up the two hydraulic couplers to the infeed conveyor hydraulic motor and connect the "full elevator" limit switch. (A Figure 7)
- 4) Find a reasonably level area to perform the following installation and adjustments.
- 5) Hook-up the accumulator to the rear hitch of the press. The hook-up should be at or as near as possible to the center of the bale discharge outlet. Position or line-up the machine in order to have an acceptable angle between the inlet guide tubes and the elevator section to assure free movement of the bales into the elevator section. Usually, the left side of the infeed section should be more or less in line with the left side of the baler. (Figure 8) Lock the tongue in position using the two pins provided. (Figure 9)

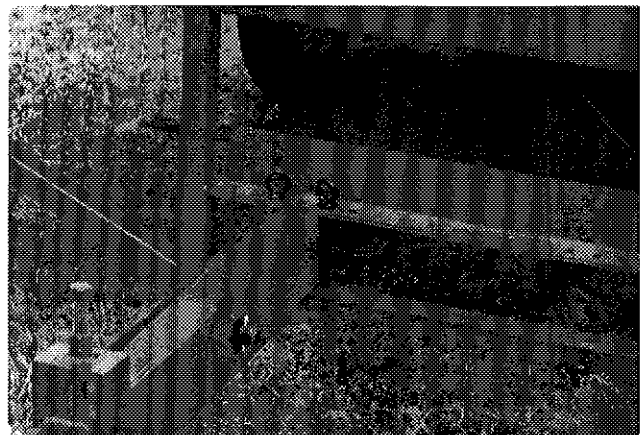

Figure 9

START-UP

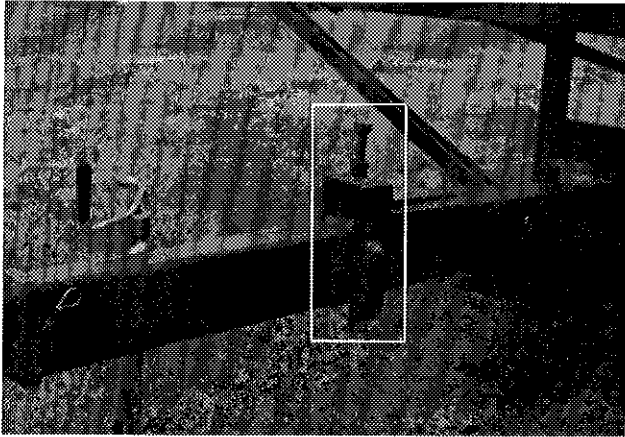

Figure 10

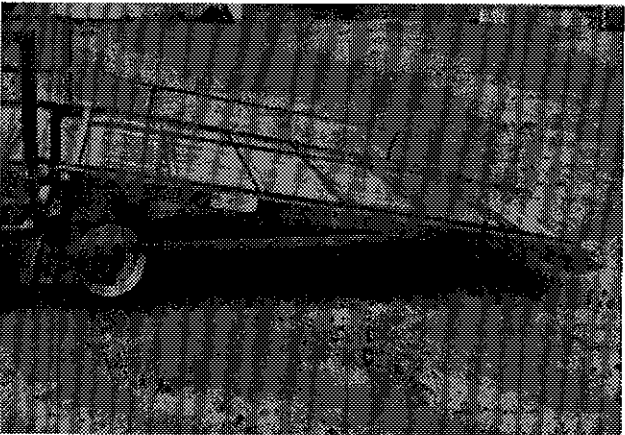

Figure 11



Figure 12

- 6) Use the level adjustment built-into the tongue to adjust the accumulator parallel to the ground and lock it in position. (Figure 10)
- 7) Install the telescoping guide rails between the baler and the inlet of the elevator section, with the larger tubes forward.
- 8) Install the inclined accumulator table as shown. (Figure 11) Connect the hydraulic hoses to the conveyor hydraulic motor. (Figure 12)
- 9) Check the ground clearance at the rear end of the inclined table (Figure 11), it should be approximately 2 to 3 inches. If necessary, adjust with the screws provided. (Figure 13) Make sure both sides are at the same elevation.
- 10) Now it is time to hook-up the two hydraulic hoses to the tractor. Secure the hoses properly over the baler leaving enough slack to allow for proper manoeuvring without pulling or damaging the hoses. The same procedure applies to the electric cable and control unit.
- 11) Install the control unit in a convenient location for easy access by the tractor operator.

4

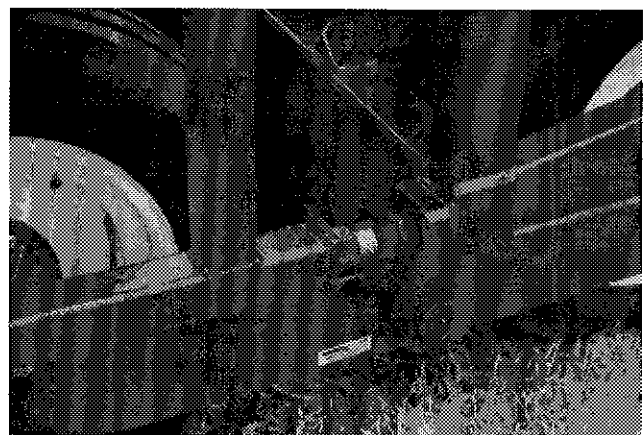

Figure 13

START-UP



4 Figure 14



Figure 15

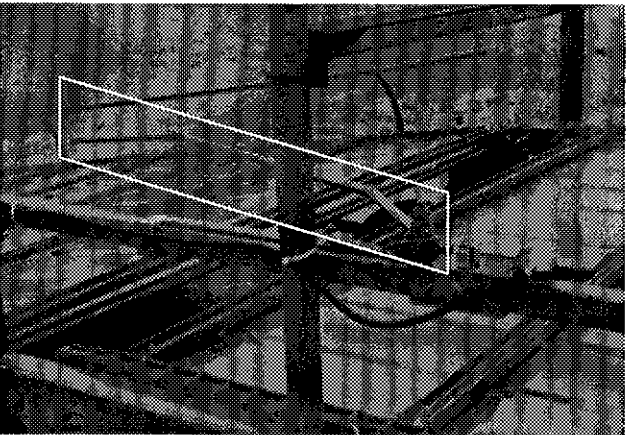

Figure 16

SYSTEM VERIFICATION

- 1) Make sure there is nothing on or around the machine which may interfere or get caught in any part of the system.
- 2) Start the tractor engine and provide hydraulic power to the system.
- 3) The infeed conveyor should start operating.
- 4) Check all hydraulic connections and lines for leaks.
- 5) Check every function of the machine as follows:
 - 5.1 - Set the bypass switch to "OFF".
 - Set the unloading switch to "OFF".
 - 5.2 - Set the control switch to the "ON" position, the infeed conveyor should start operating.
 - 5.3 - Standing behind the full elevator switch as shown (Figure 14), pull the actuator lever and hold momentarily. The bale elevator should go up and complete one full cycle (Figure 15). During that sequence, the infeed conveyor should stop operating since the normally closed hydraulic valve will have mechanically been released by the elevator going up.
 - 5.4 Transfer sequence check:
 - Have someone stand near the full accumulator switch (Figure 16) and hold the switch actuator to simulate a full accumulator. The buzzer should sound. At this point, momentarily press the transfer push button to activate the two accumulator conveyors and the pilot light. Releasing the switch actuator should stop the two conveyors and turn off the pilot light.
- 6) **"BYPASS" function check**
Set the "Bypass" switch to the "ON" position and then momentarily press the transfer button, the two accumulator conveyors should start. Now set the "Bypass" switch to the "OFF" position and the two conveyors should stop.

START-UP

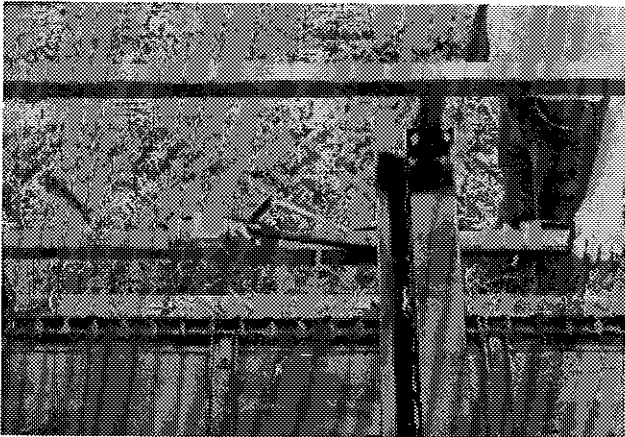

Figure 17

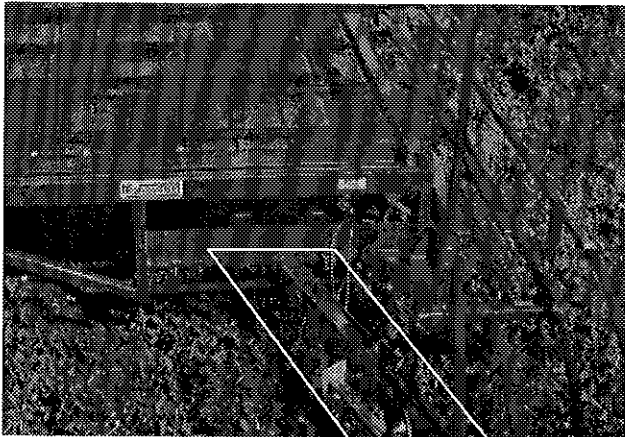

Figure 18

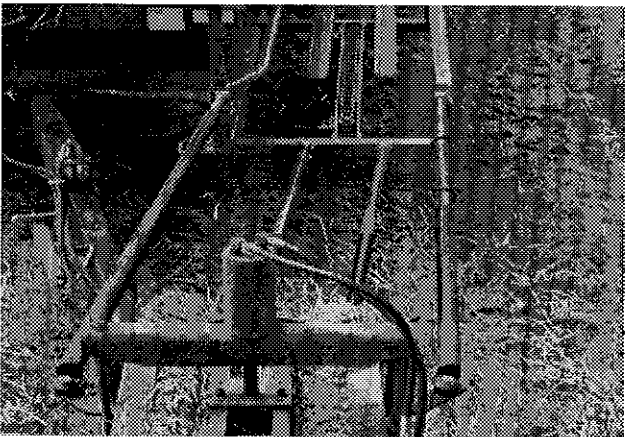

Figure 19

7) Unloading sequence check

Manually actuate and hold the full accumulator switch (Figure 17). Then press the Transfer Push Button, both conveyors should operate (pilot light on) and stop when the switch is released. Then set the unloading switch to the "ON" position to start conveyor #2 (Pilot light on). Then set the switch to off position again to stop #2 conveyor (pilot light off).

ADJUSTMENTS

- 1) The length of the tongue and its angle must be adjusted (Figure 18) so that when a turn is being negotiated, the telescoping rails (Figure 19) are not extended beyond their maximum operating length nor beyond their shortest possible dimension to avoid bottoming. This must be checked when turning in both directions.
- 2) Make sure the elevator front bale retainer (Figure 20) is operating freely. (Spring loaded and not adjustable.)

4

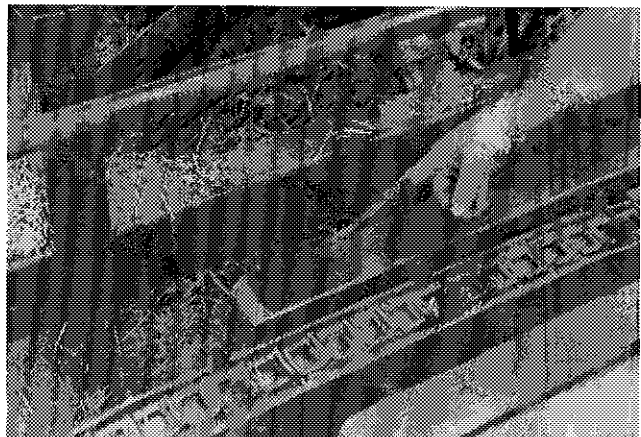

Figure 20

START-UP

4

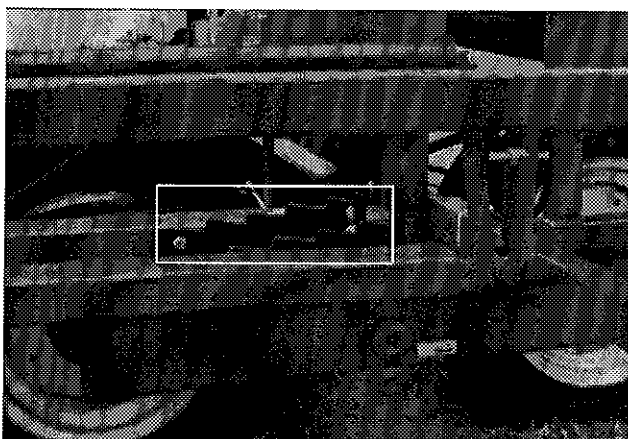

Figure 21

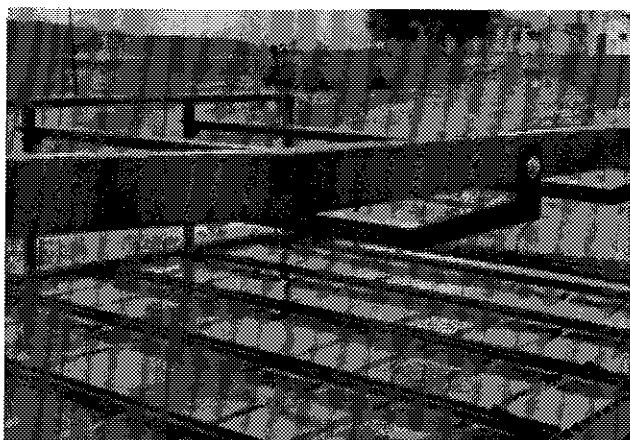

Figure 22

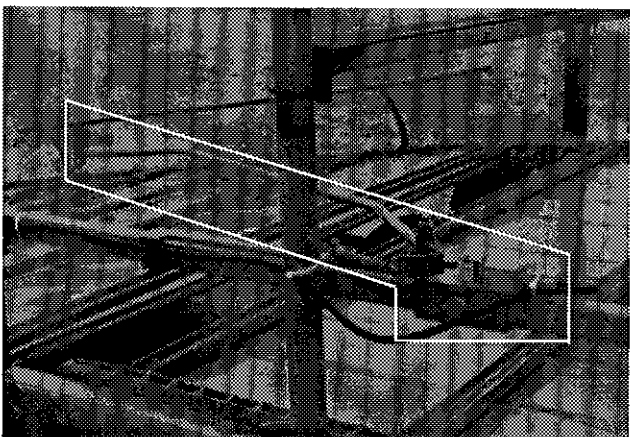

Figure 23

- 3) Adjust the two bale friction pads (Figure 21) so that the first bale in the elevator section will not slide on its own and trip the "full elevator switch" when the machine is going uphill.
- 4) Adjust the bale stabilizer bars (Figure 22) to maintain a gap of approximately one half ($\frac{1}{2}$ ") to one (1") inch above the bales.
- 5) As previously described in the installation section, item 9 page 9, adjust the ground clearance of the inclined accumulator table to approximately two (2") to three (3") inches. It is meant to occasionally drag on the ground when operating in uneven terrain.
- 6) Adjust the position of the "full accumulator" switch actuator (Figure 23) so that when the transfer of a lot of 18 bales is made, the rear corner bale will release the switch at the right moment and stop the inclined table conveyor in proper position.
- 7) Hydraulics
 - Flow control valve #7: Adjust to reduce oil volume if needed.
 - Pressure control valve #6: adjust at 2000 psi.

OPERATION

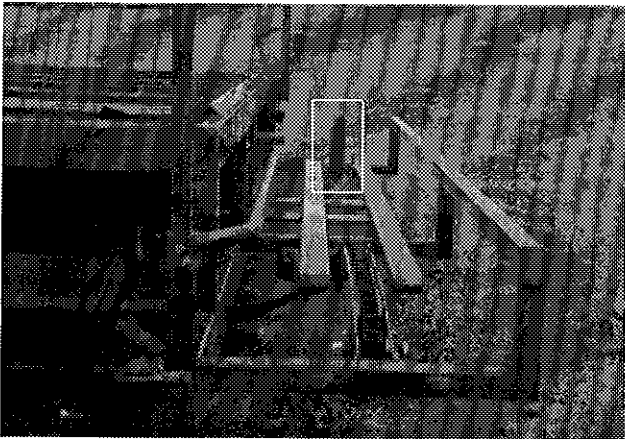

Figure 24

Please remember that one of the main features of the PC-1836 is to enable you to bunch the 18 bale lots at a desired location(s) in the field.

- 1) Make sure the control unit is positioned for easy access and use by the tractor operator. Set the "Control Switch" to "ON".
- 2) Operate the system at the normal operating speed of your baler. Speed is reduced only during the unloading sequence.
- 3) When #1 table is full, the buzzer will sound, at that moment, press the "Transfer Button". The lot will be automatically transferred to #2 table. The pilot light will come on indicating that the conveyors are operating.
- 4) If at that point or some time later you wish to unload this first lot which has just been transferred to #2 table and this while the #1 table is being loaded, set the "Unloading Switch" to "ON", the pilot light will come on to indicate that the #2 conveyor is operating. Immediately reduce your travel speed to a rate slightly lower than the speed of the conveyor in order to prevent separation of the bales on the ground. As soon as the unloading is completed, set the "Unloading Switch" back to the "OFF" position.
- 5) When both tables are full, you must reduce your travel speed as soon as you press the "Transfer Button" since the lot on table #2 will be unloaded at that time. At this point, you have the choice of also unloading the lot being transferred (see 4 above) or let it remain on table #2 for unloading at another location in the field.
- 6) To clear a partial load at the end of a run, empty the elevator section by manually actuating the "Full Elevator" switch (Figure 24) then chose the location in the field where you wish to unload this partial load. Set the "Bypass" switch to "ON" and press the "Transfer Button", the two conveyors will operate (pilot light on) and empty the machine. Set the "Bypass" switch and the "Control" switch to "OFF".

5

MAINTENANCE

- 1) Wipe off all grease fittings with a clean cloth before adding grease in order to avoid injecting dirt or sand.
- 2) Repair or replace damaged grease fittings.
- 3) Lubricate all grease fittings every 20 hours of operation.
- 4) Check all bolts on wheels after first 5 hours of operation and then every 50 hours of operation.
- 5) Check tire pressure every 50 hours of operation, adjust according to manufacturer's recommendation indicated on the tires.
- 6) Open, clean and lubricate wheel bearings once a year.
- 7) Check all nuts and bolts once a year. If necessary use torque chart on page 22.

6

STORAGE

- 1) Store in a cool, dry place.
- 2) Install wooden blocks under the axles to keep the tires off the ground and cover them if left exposed to the sun.
- 3) Keep all piston rods in the retracted position. This will assure better protection against the elements.
- 4) Clean your Bale Accumulator.
- 5) Thoroughly inspect all parts of the Bale Accumulator. Replace or repair worn or defective parts.
- 6) Touch-up or repaint if necessary.
- 7) Lubricate all points before storage.

TROUBLE SHOOTING

PROBLEM	POSSIBLE CAUSE	CORRECTION
- Controls not operating.	- Control switch "OFF" - Blown fuse. - Poor connection at power source.	- Set control switch to "ON" - Replace fuse. - Verify connections.
- Infeed conveyor will not operate.	- Low or no hydraulic pressure. - Mechanical control valve #13 not fully open.	- Pressurize system or adjust pressure control valve #6 and flow control valve #7. - Adjust valve actuator screw.
- Infeed conveyor will not stop.	- Mechanical control valve #13 not closing properly.	- Check spring tension on valve stem.
- Elevator not lifting.	- Full elevator switch LS-1 not fully actuated. - Defective LS-1 switch. - Defective control relay CR-4. - Defective selenoid valve #4.	- Adjust switch actuator. - Replace switch. - Replace control relay. - Repair or replace valve.
- Elevator not raising fully.	- Defective switch LS-2. - Defective relay CR-1.	- Repair or replace switch. - Repair or replace relay.
- Elevator not lowering.	- Elevator-up switch LS-3 not actuated. - LS-3 switch defective. - Defective selenoid valve #4. - Defective control relay CR-1.	- Adjust switch position. - Repair or replace switch. - Repair or replace valve. - Repair or replace relay.
- No 1 Accumulator conveyor not operating.	- Full accumulator switch LS-4 not actuated or defective. - Defective Transfer push button #2.	- Adjust switch position, repair or replace switch. - Repair or replace contacts.
- No 1 Accumulator conveyor starts and then stops when push button #2 is released.	- Defective control relay CR-6.	- Repair or replace relay.
- No 1 Accumulator conveyor not stopping.	- Limit switch LS-4 defective or not fully released.	- Reposition, repair or replace switch.
- No 2 Accumulator conveyor will not stop.	- Transfer switch #4 "ON" - Defective control relay. - Unloading switch #3 "ON".	- Set switch to "OFF". - Repair or replace relay. - Set switch to "OFF".
- Buzzer not sounding.	- Full accumulator switch LS-4 not actuated or defective. - Defective buzzer.	- Adjust position, repair or replace switch. - Replace buzzer.

SPECIFICATIONS

MODEL	PC-1836
Capacity	36 bales
Platform height	46"
Overall length	25'
Overall width	10'6"
Tires	4 x 5.9 x 15
Weight	3,725 lbs.

Design and specifications subject to change without notice.

PC-1836 ELECTRIC SYSTEM

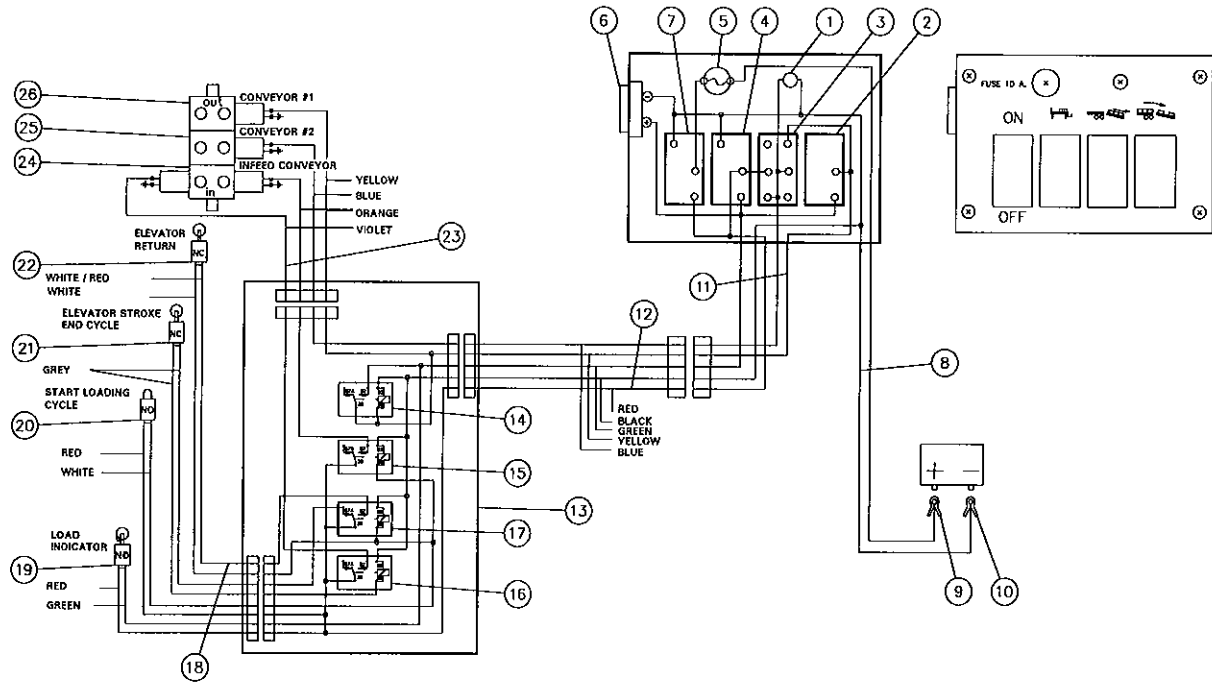

REF.	PART #	DESCRIPTION	QTY
1	18001	Pilot light	1
2	18002	Push button (activates the two conveyors)	1
3	18003	Switch DPDT for unloading (activates conveyor #2)	1
4	18004	Switch SPDT (bypass load indicator)	1
5	18005	Fuse 10A	1
6	18006	Buzzer (indicates conveyor #1 full)	1
7	18004	Switch SPDT	1
8	18008	Harness (for battery)	1
9	18009	Battery clip (red)	1
10	18010	Battery clip (black)	1
11	18011	Harness (control box side)	1
12	18012	Harness (power box side)	1
13	18013	Power box	1
14	18014	Control relay CR-6	1
15	18014	Control relay CR-4	1
16	18014	Control relay CR-2	1
17	18015	Control relay CR-1	1
18	18016	Harness (for limit switch)	1
19	18017	LS-4 Limit switch normally open (load indicator, activates the elevator)	1
20	18007	LS-1 Limit switch normally open (starts loading cycle & stops infeed conveyor) ..	1
21	18017	LS-2 Limit switch normally closed (elevator stroke end cycle)	1
22	18017	LS-3 Limit switch normally closed (loader return)	1
23	18018	Harness (for selenoid valve)	1
24	18019	Selenoid valve for infeed conveyor	1
25	18019	Selenoid valve for conveyor #2	1
26	18019	Selenoid valve for conveyor #1	1

10

PC-1836 HYDRAULIC SYSTEM

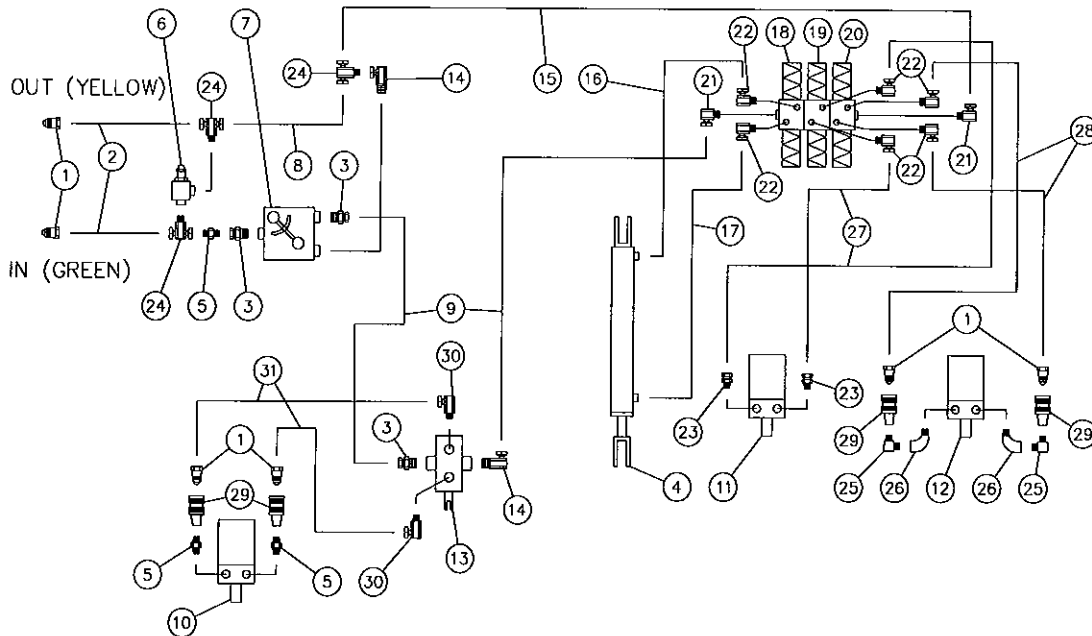

REF.	PART #	DESCRIPTION	QTY
1	Std.	Quick coupler 1/2" male	6
2	D-17052	Hose 3/8" x 432" lg + 2 fittings 6U108	2
3	Std.	Fitting 9205 8 x 18	3
4	25TR08	Cylinder 2 1/2" ø x 8" stroke	1
5	Std.	Fitting C3069 x 8	3
6	18020	Pressure control valve 1/2" NPT	1
7	18021	Flow control valve	1
8	D-17053	Hose 3/8" x 7 3/4" lg + 2 fittings 6U108	1
9	D-17054	Hose 3/8" x 24" lg + 2 fittings 6U108	2
10	DH-315	Hydraulic motor	1
11	DH-315	Hydraulic motor	1
12	DH-315	Hydraulic motor	1
13	18022	Pressure control valve (modified)	1
14	Std.	Fitting 9405 8 x 12	2
15	D-17055	Hose 3/8" x 64" lg + 2 fittings 6U108	1
16	D-17056	Hose 3/8" x 8" lg + 1 fitting 6U106 & 1 fitting 6U108	1
17	D-17057	Hose 3/8" x 12 1/2" lg + 1 fitting 6U106 & 1 fitting 6U108	1
18	18019	Solenoid valve for conveyor #1	1
19	18019	Solenoid valve for conveyor #2	1
20	18019	Solenoid valve for infeed conveyor	1
21	Std.	Fitting 9515 8 x 8	2
22	Std.	Fitting 9515 8 x 8	6
23	Std.	Fitting 9205 8 x 8	2
24	Std.	"T" 1/2" NPTM x 1/2" NPTF swivel	3
25	Std.	Fitting 1094 x 8	2
26	Std.	Fitting 15855 x 8 x 8 x 8	2
27	D-17058	Hose 3/8" x 92" lg + 2 fittings 6U108	2
28	D-17059	Hose 3/8" x 105" lg + 2 fittings 6U108	2
29	Std.	Quick coupler 1/2" female	4
30	Std.	Fitting 9405 8x8	2
31	D-17060	Hose 3/8" x 51" lg + 2 fittings 6U108	2

CYLINDER 25TR08

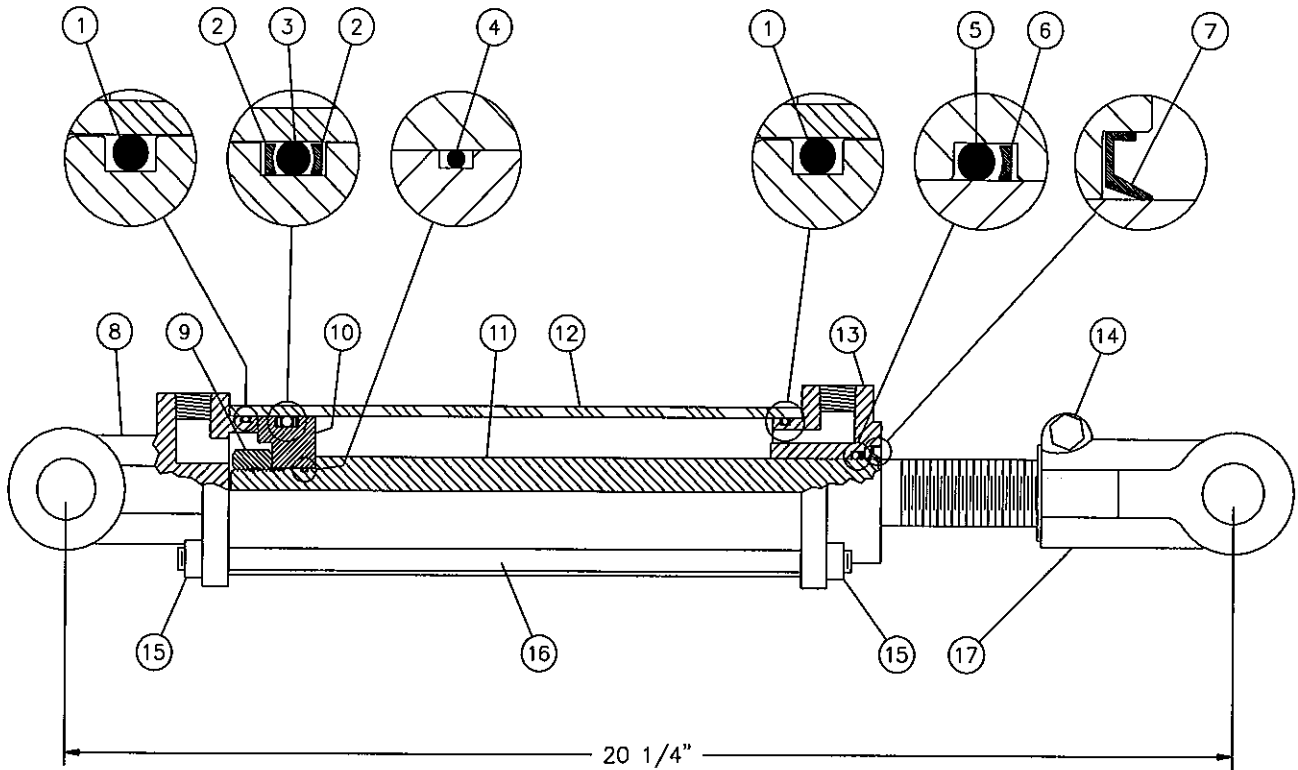

REF.	PART #	DESCRIPTION	QTY
1	See RK25TR	O-ring 1/8" x 2 1/4" x 2 1/2"	2
2	See RK25TR	Back-up 2 1/2" o.d. x 3/16 ø	2
3	See RK25TR	O-ring 3/16" x 2 1/8" x 2 1/2"	1
4	See RK25TR	O-ring 1/16" x 5/8" x 3/4"	1
5	See RK25TR	O-ring 1/8" x 1 1/8" x 1 3/8"	1
6	See RK25TR	Back-up 1 3/8" o.d. x 1/8" ø	1
7	See RK25TR	Wiper 1 1/8" i.d. x 1 5/8" o.d.	1
8	492401	Yoke (for 2 1/2" tube)	1
9	Std.	Nut 3/4" NF	1
10	4924-31	Piston 2 1/2" ø	1
11	491980	Piston rod 1 1/8"	1
12	491668	Cylinder body 2 1/2" ø	1
13	492421	Head 2 1/2"	1
14	Std.	Bolt 3/8" NC x 2 1/4" lg + nut	1
15	Std.	Nut 3/8" NC	8
16	Std.	Threader rod 3/8" NC x 12" lg	4
17	458599	Yoke (for 1 1/8" rod)	1
NI*	8183	Pin 1" ø + cotter pin	2
NI*	RK25TR	Repair kit for cylinder 2 1/2" (includes # 1, 2, 3, 4, 5, 6, & 7)	1

10

*NI = NOT ILLUSTRATED

HYDRAULIC MOTOR # DH 315

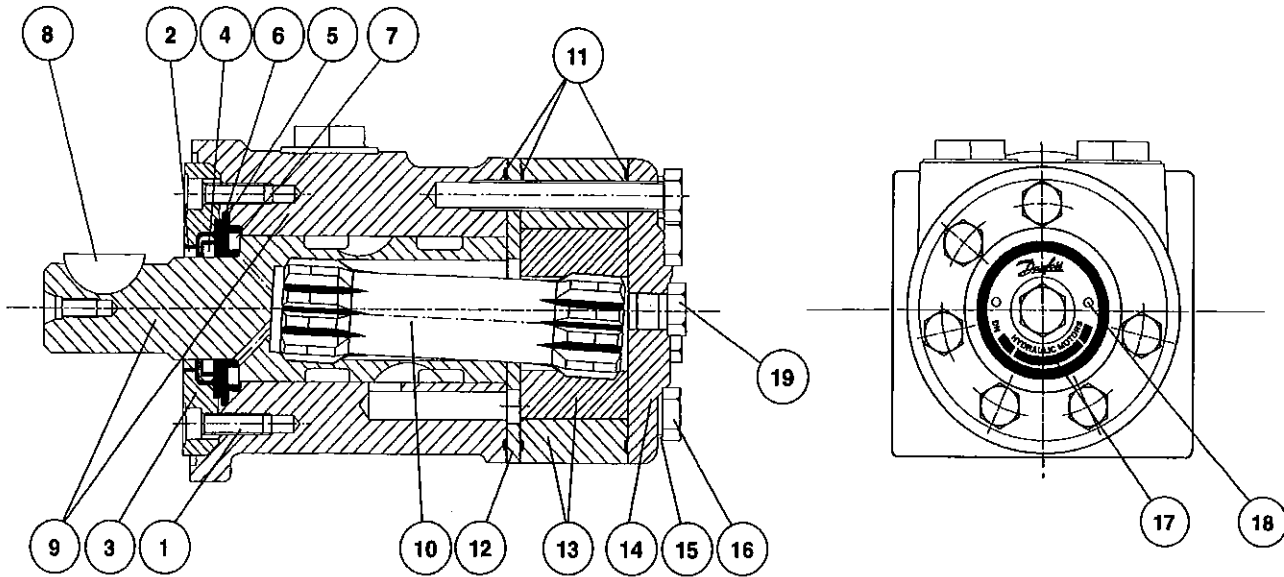







REF.	CODE #	DESCRIPTION	QTY
			DH 315
1	681X1961	Screw M5 x 16mm	6
2	151-1313	Dust seal ring	1
3	151-1827	Spigot flange	1
4	633B3385	Shaft seal BAKDH ring	1
5	633B1333	O-ring	1
6	151-1608	Bearing race	1
7	151-1458	Axial needle bearing	1
8	682L9054	Woodruff key	1
9	-----	Housing and output shaft	not sold
10	151-2650	Cardan shaft	1
11	633B1173	O-ring	3
12	151-1713	Distributor plate	1
13	151-1186	Gear wheel set	1
14	151-2641	End cover	1
15	684X2481	Washer	6
16	681X0186	Screw M8 x 1.25mm Din 931 x 70mm lg	6
17	151A0415	Name plate	1
18	681Z1011	Drive screw	2
19	631X2013	Drain plug 7/16"-20 UNF	1
NI*	151-1273	Set of seals	1





*NI = NOT ILLUSTRATED

TORQUE CHART

TORQUE SPECIFICATION TABLE

Thread UNC and UNF		Grade 2 				Grade 5   				Grade 8*   			
Bolt size		Torque				Torque				Torque			
Inches	mm	Pound feet min.	Pound feet max.	Newton meters min.	Newton meters max.	Pound feet min.	Pound feet max.	Newton meters min.	Newton meters max.	Pound feet min.	Pound feet max.	Newton meters min.	Newton meters max.
1/4	6.35	5	6	6.8	8.13	9	11	12.2	14.9	12	15	16.3	30.3
5/16	7.94	10	12	13.6	16.3	17	20.5	23.1	27.8	24	29	32.5	39.3
3/8	9.53	20	23	27.1	31.2	35	42	47.5	57.0	45	54	61.0	73.2
7/16	11.11	30	35	40.7	47.4	54	64	73.2	86.8	70	84	94.9	113.9
1/2	12.70	45	52	61.0	70.5	80	96	108.5	130.2	110	132	149.2	179.0
9/16	14.29	65	75	88.1	101.6	110	132	149.2	179.0	160	192	217.0	260.4
5/8	15.88	95	105	128.7	142.3	150	180	203.4	244.1	220	264	298.3	358.0
3/4	19.05	150	185	203.3	250.7	270	324	366.1	439.3	380	456	515.3	618.3
7/8	22.23	160	200	216.8	271.0	400	480	542.4	650.9	600	720	813.6	976.3
1	25.40	250	300	338.8	406.5	580	696	786.5	943.8	900	1080	1220.4	1464.5
1 1/8	25.58	-	-	-	-	800	880	1084.8	1193.3	1280	1440	1735.7	1952.6
1 1/4	31.75	-	-	-	-	1120	1240	1518.7	1681.4	1820	2000	2467.9	2712.0
1 3/8	34.93	-	-	-	-	1460	1680	1979.8	2278.1	2380	2720	3227.3	3688.3
1 1/2	38.10	-	-	-	-	1940	2200	2630.6	2983.2	3160	3560	4285.0	4827.4

* Thick nuts must be used with grade 8 bolts.

Size of screw	Thread	Pitch (mm)	Grade 4T  				Grade 7T 				Grade 8T  			
			Torque				Torque				Torque			
			Pound feet min.	Pound feet max.	Newton meters min.	Newton meters max.	Pound feet min.	Pound feet max.	Newton meters min.	Newton meters max.	Pound feet min.	Pound feet max.	Newton meters min.	Newton meters max.
M6	UNC	1.00	3.6	5.8	4.9	7.9	5.8	9.4	7.9	12.7	7.2	10	9.8	13.6
M8	UNC	1.25	7.2	14	9.8	19	17	22	23	29.8	20	26	27.1	35.2
M10	UNC	1.5	20	25	27.1	33.9	34	40	46.1	54.2	38	46	51.5	62.3
M12	UNC	1.75	28	34	37.9	46.1	51	59	69.1	79.9	57	66	77.2	89.4
M14	UNC	2.0	49	56	66.4	75.9	81	93	109.8	126	96	109	130.1	147.7
M16	UNC	2.0	67	77	90.8	104.3	116	130	157.2	176.2	129	145	174.8	196.5
M18	UNC	2.0	88	100	119.2	136	150	168	203.3	227.6	175	194	237.1	262.9
M20	UNC	2.5	108	130	146.3	176.2	186	205	252	277.8	213	249	288.6	337.4
M8	UNF	1.0	12	17	16.3	23	19	27	25.7	36.6	22	31	29.8	42
M10	UNF	1.25	20	29	27.1	39.3	35	47	47.4	63.7	40	52	54.2	70.5
M12	UNF	1.25	31	41	42	55.6	56	68	75.9	92.1	62	75	84	101.6
M14	UNF	1.5	52	64	70.5	86.7	90	106	122	143.6	107	124	145	168
M16	UNF	1.5	69	83	93.5	112.5	120	138	162.6	187	140	158	189.7	214.1
M18	UNF	1.5	100	117	136	158.5	177	199	239.8	269.6	202	231	273.7	313
M20	UNF	1.5	132	150	178.9	203.3	206	242	279.1	327.9	246	289	333.3	391.6

Use the above torques when special torque is not given.

NOTE: These values apply to fasteners as received from supplier, dry, or when lubricated with normal engine oil. They do not apply if extreme pressure lubricants are used.

WARRANTY

PRONOVOST warrants this product to the initial purchaser for the period of one year from the date of purchase against defects in materials and workmanship.

We will replace or repair defective parts free of charge if they are returned to our plant in St-Tite, Quebec, Canada.

Transportation charges are the responsibility of the customer. This warranty is not transferable.

Hydraulic cylinders and tires are covered by the manufacturers of these items.

All PRONOVOST spare parts purchased are covered by a three (3) month warranty.

This warranty becomes void and nul if the equipment is modified, breaks down as the result of an accident, is not operated according to manufacturer's recommendations, damaged by negligence or if maintenance has not been carried out as specified.

Our obligation is limited to the replacement or repair of the defective part. PRONOVOST accepts no responsibility for direct or indirect consequential damages of any kind.

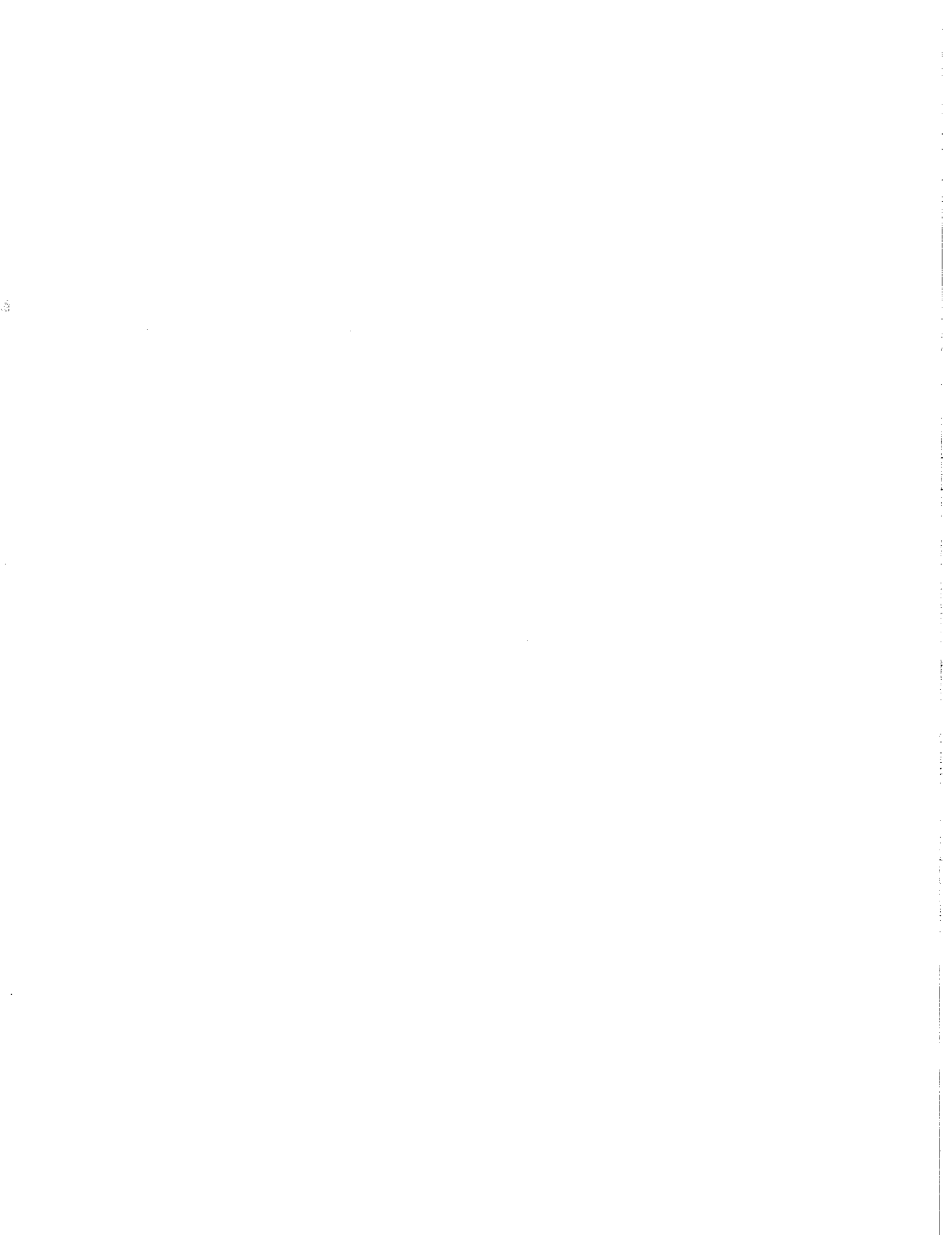

Ce manuel est aussi disponible en français.
Veuillez téléphoner.



LES MACHINERIES PRONOVOST INC.
260, route 159,
Saint-Tite, Quebec, Canada, G0X 3H0
Tel.: (418) 365-7551, Fax: (418) 365-7954