

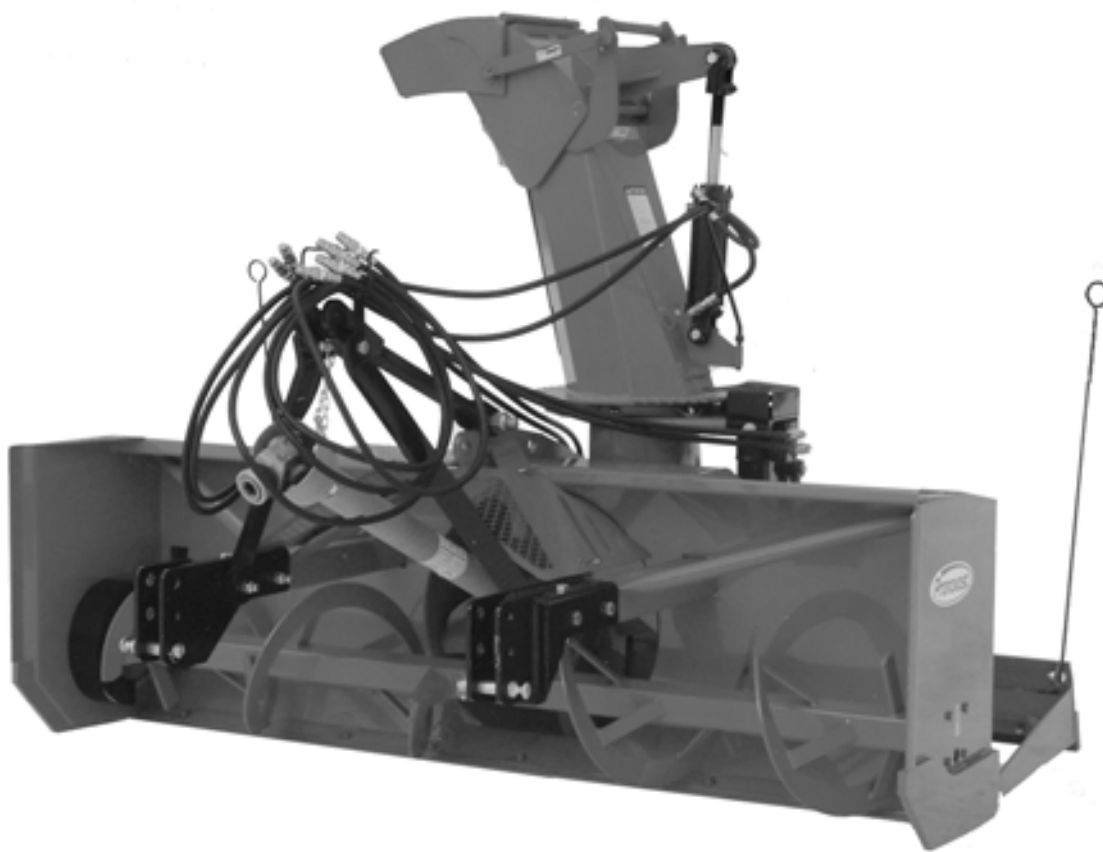

**OPERATOR'S / PARTS  
MANUAL**



***Inverted snowblower***

**Models**

**P-860IV**

**&**

**P-920IV**



Copyright © Les Machineries Pronovost Inc., 2008

All rights reserved.  
Printed in Canada.

---

---

# ***TABLE OF CONTENTS***

---

---

<b>Section</b>	<b>Item</b>	<b>Page</b>
<b>1</b>	<b>Introduction .....</b>	<b>5</b>
<b>2</b>	<b>Safety .....</b>	<b>6</b>
	General Safety .....	6
	Safety in operation .....	6
	Safety with maintenance .....	7
	Safety in transport .....	7
	Safety in storage .....	7
<b>3</b>	<b>Decals .....</b>	<b>8</b>
	Safety Decals .....	8
	Maintenance Decals .....	11
<b>4</b>	<b>Assembly .....</b>	<b>12</b>
	General assembly .....	12
<b>5</b>	<b>Start-up .....</b>	<b>13</b>
	Basic Start-up Procedures .....	13
<b>6</b>	<b>Maintenance .....</b>	<b>14</b>
<b>7</b>	<b>Storage .....</b>	<b>15</b>
<b>8</b>	<b>Trouble Shooting .....</b>	<b>16</b>
<b>9</b>	<b>Specifications .....</b>	<b>18</b>
<b>10</b>	<b>Parts List .....</b>	<b>19</b>
	Inverted Snowblowers P-860IV, P-920IV .....	19
	Semi-industrial Chute PSIG-7486IV .....	23
	P.T.O. Shaft # 190-00471 .....	24
	Gear Box # 190-01491 .....	25
	Cylinder 25TR08 .....	26
	Hydraulic Motor MLH-315 .....	27
<b>11</b>	<b>Torque chart .....</b>	<b>28</b>
<b>12</b>	<b>Warranty .....</b>	<b>29</b>



---

---

# INTRODUCTION

---

---

Your Snowblower was carefully designed and we are confident it will meet your requirements in terms of quality, performance and reliability.

This manual was prepared to assist you in the safe operation of your new Snowblower. It contains important information which will help you achieve excellent returns with your Snowblower.

Please read this manual completely before operating your Snowblower and keep it for future reference.

Before starting the machine, you or any other person who will be operating the Snowblower must familiarize yourself with the safety recommendations and the operating instructions. Please read carefully and be sure to understand and follow all recommendations and procedures.

In this manual, the right side of the Snowblower is the drive chain side.

If you require additional information on your Snowblower, please contact your PRONOVOST Dealer.

When ordering parts from your Dealer, please refer to these numbers for a fast and efficient service. Use PRONOVOST parts for replacement.  
When ordering parts from your Dealer, please refer to these numbers for a fast and efficient service. Use PRONOVOST parts for replacement.

**NOW** take a moment to enter the model, serial number and the date of purchase of your Snowblower in the space provided.

The model and serial numbers are on the name plate shown on Fig. 1.

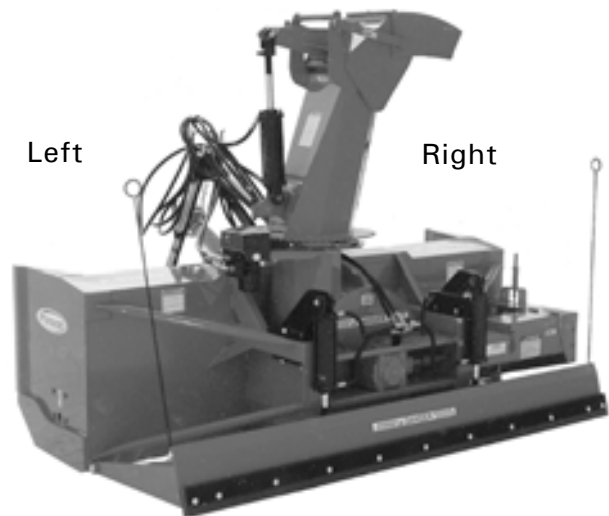

Figure 1

MODEL: \_\_\_\_\_ ✍

SERIAL NO.: \_\_\_\_\_ ✍

DATE OF PURCHASE: \_\_\_\_\_ ✍

---

---

# ***SAFETY***

---

## ***GENERAL SAFETY***

### **WHEN YOU SEE THIS SYMBOL**



**ATTENTION!**

**BE ALERT  
YOUR SAFETY IS INVOLVED**

This symbol «**SAFETY ALERT**» is used in this manual and on the safety decals on the Snowblower. It warns you of the possibility of danger. Carefully read, understand and follow all safety recommendations before operating the Snowblower.

- 1) Careful operation is the best assurance against accidents. Carefully read this manual and follow all recommendations before operating your Snowblower. It is the owner's responsibility to make sure that anyone who will operate the Snowblower will read this manual before operating the equipment.
- 2) Familiarize yourself with all controls and always be ready to stop the Snowblower quickly in case of emergency.
- 3) Never let a child operate the Snowblower.
- 4) Do not modify the Snowblower. Any non authorized modification may affect the efficiency and/or safety of the equipment.
- 5) Never operate the Snowblower with defective parts or if damaged in any way. Have it repaired before operating.
- 6) Make sure all fasteners are in place and properly secured or tightened. Refer to torque chart on page 28.
- 7) Avoid wearing loose fitting clothing when working with the Snowblower. These could get entangled in moving parts of the equipment and cause accidents.

- 8) Prolonged exposure to noise may hamper hearing. Protect yourself by wearing adequate protection devices.
- 9) Hydraulic fluids under pressure can damage your skin. Do not use your hands to locate a leak.
- 10) Before the beginning of the snow season, inspect all areas where the Snowblower will be used and remove any object which may cause an accident and/or damage the equipment.
- 11) Never operate your Snowblower in poor visibility or without proper lighting conditions.

## ***SAFETY IN OPERATION***

- 1) Be sure there are no obstructions around the equipment and that no one stands near the equipment when in operation.
- 2) Do not operate an engine in a confined or non ventilated area.
- 3) Do not perform any adjustments, cleaning, maintenance or repairs with the engine running. The engine must be stopped and the P.T.O. disengaged. Preferably remove the key from the ignition.
- 4) Wear adequate clothing when working in cold or windy conditions.
- 5) Before operating, make sure the P.T.O. is properly installed and secured.
- 6) Before starting-up the Snowblower, make sure the auger and drum areas are free of ice.
- 7) Put P.T.O. control in neutral position before starting engine.
- 8) Keep hands, feet and clothing away from moving parts of the Snowblower. Stay away from the discharge chute.
- 9) Before unplugging the chute, always disengage the P.T.O., stop the engine and relieve all hydraulic pressures.

---

---

## ***SAFETY (cont'd)***

---

- 10) Do not operate in excessive inclined conditions. Be careful when turning in slopes.
- 11) Never operate your Snowblower with missing guards or without protective devices in place.
- 12) Do not operate your Snowblower near buildings, windows or other vehicles without prior and proper adjustment of the chute deflector.
- 13) Never aim discharge chute towards people or animals. This may cause serious injuries.
- 14) Always reduce operating speed in slippery conditions.
- 15) Be careful when backing-up, make sure you have good visibility.
- 16) Always be on the lookout for objects which may enter the Snowblower.
- 17) If undue vibrations are felt, disengage the P.T.O., stop the motor and look for the cause of the vibration. Vibration is usually the indication of a problem.
- 18) At the end of the operation, disengage the P.T.O., lower the Snowblower, put transmission in neutral, apply parking brake, stop engine and remove the key from the ignition.

### ***SAFETY WITH MAINTENANCE***

- 1) Perform the Snowblower maintenance according to recommendations contained in this manual.
- 2) Stop engine and relieve all hydraulic pressures before doing inspection, maintenance or repairs.
- 3) Never perform any work under the Snowblower while it is supported only by the tractor's hydraulic system. It must be completely supported by wooden blocks or other safe means.

### ***SAFETY IN TRANSPORT***

- 1) On public roads, use proper safety lights and check local regulations.
- 2) Be alert while driving on the road. Never carry passengers.
- 3) Always disengage P.T.O. while moving from one area of work to another.
- 4) The recommended road speed should be such as to maintain full control over steering and braking.
- 5) Be careful while backing up, make sure you have good visibility.

### ***SAFETY IN STORAGE***

- 1) Provide adequate supports to prevent any accidental overturning of the Snowblower.
- 2) Do not let children play in the area where the Snowblower is stored.

# DECALS

## SAFETY DECALS

The safety decals are affixed wherever special safety precautions are indicated. Locate them on the machine and read them carefully. If a decal is damaged, lost or illegible, install a new one. Each decal is shown and identified with a part number.

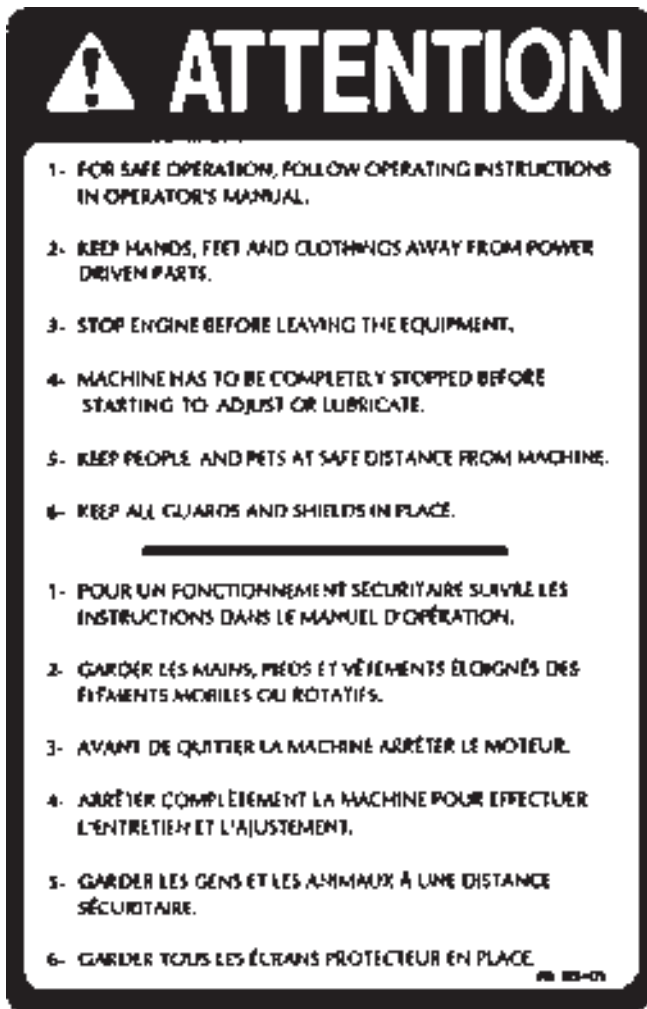

Figure 2  
Part no.: A102



Figure 3  
Part no.: A101

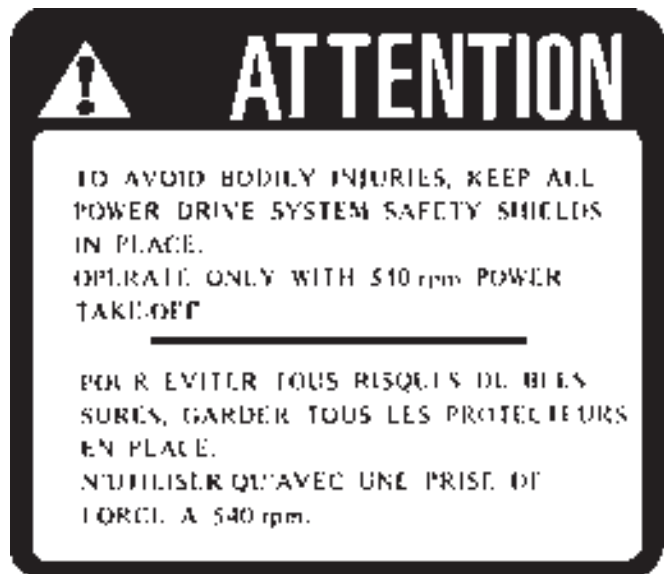

Figure 4  
Part no.: A107



# DECALS (cont'd)

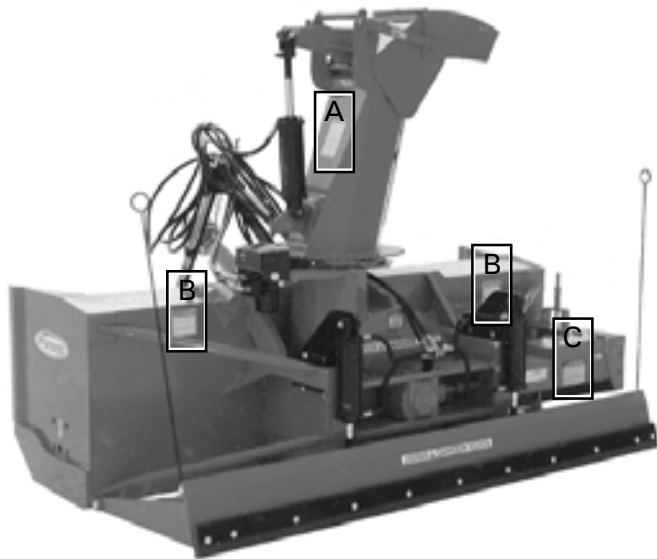

Figure 5

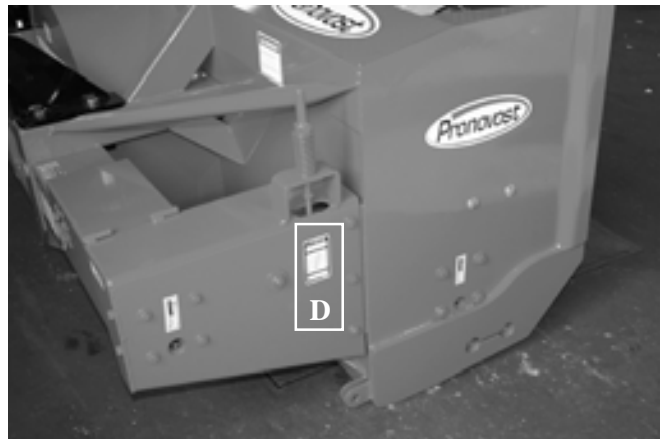

Figure 7

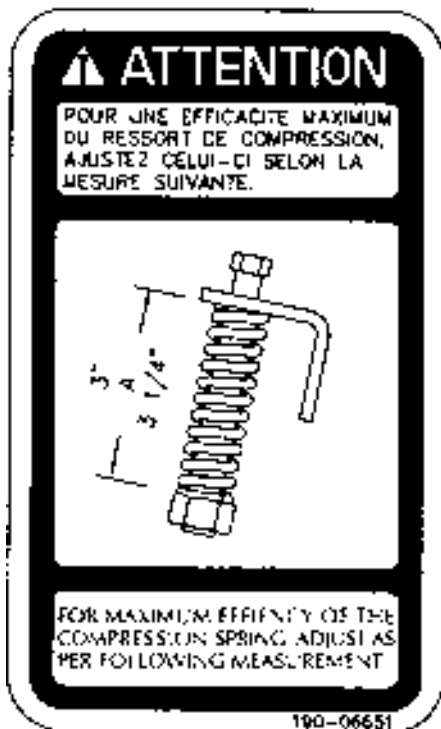

Figure 6  
 Decal D

Part no.: 190-06651

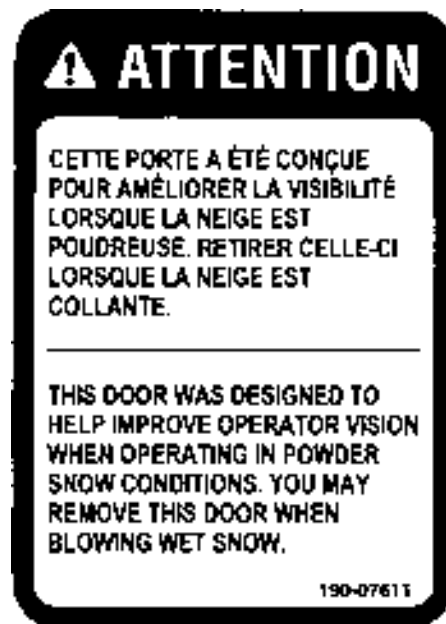

Figure 8  
 Decal E

Part no.: 190-07611

# DECALS (cont'd)



Figure 9



Figure 10  
Part no.: A 109



Figure 11  
Part no.: A108

---

---

## DECALS (cont'd)

---



Figure 12  
Decal G

Part no.: 190-10991

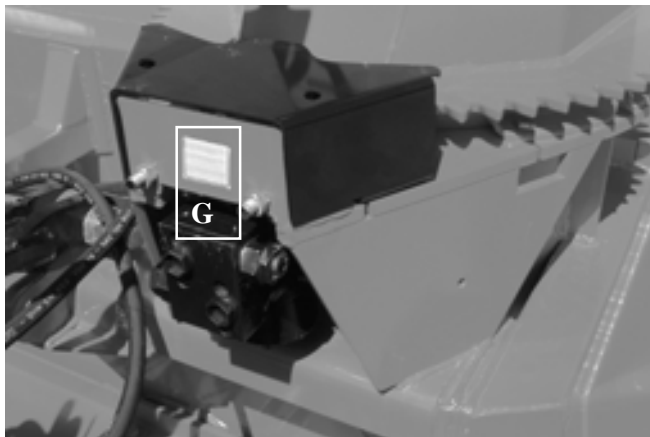

Figure 13

### MAINTENANCE DECALS

The maintenance decals indicate the points requiring lubrication. Refer to maintenance section for more details.



Figure 14

Part no.: A104



Figure 15

Part no.: A 106

---

# ASSEMBLY

---



Figure 16

## ASSEMBLY

- 1) The Snowblower is shipped partly assembled.
- 2) Install 3-point system according to the model of your Snowblower. (See section 10 for parts numbers). Use the holes most convenient to the type of tractor used (Fig. 16).
- 3) Install P.T.O. shaft onto the snowblower rotor. You must put the shear pin end to the tractor PTO output shaft and the other end on the snowblower rotor shaft. Then attach safety shield support chain as shown. **WARNING:** The telescoping tubes of the drive shaft must never be allowed to bottom out while maintaining a minimum overlap of 6 inches.
- 4) If you install a hydraulic cylinder on the chute deflector, use model 25TR08 cylinder.
- 5) When installing chute, grease the groove of the UHMW slide in order to prevent the corrosion of the rim of the chute.
- 6) Install the chute rotation mechanism.

---

# STARTING-UP

---

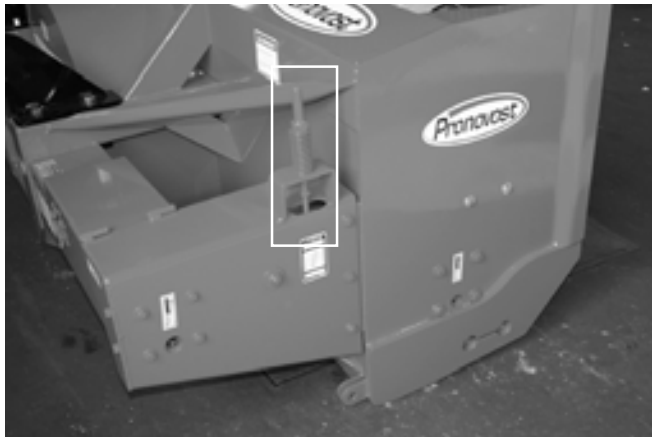

Figure 17

## START-UP PROCEDURES

- 1) Check oil level in gearbox. Adjust to required oil level as per drawing in Parts List section. Use SAE 80W90 oil.
- 2) Lubricate all points with a good quality multipurpose grease.
- 3) Check chain take-up adjustment. The spring maintaining the tension must be compressed to a length between 3" and 3 1/4" (Fig. 17).
- 4) Verify for adequate tightness of all fastening devices. Refer to torque chart on page 28.
- 5) Make sure of a 540 RPM input to your snowblower.
- 6) Check impeller adjustment. The tip of the blades should be approximately 1/8" to 3/16" from the discharge wall of the drum. If necessary, adjust with the take-up screws provided.
- 7) In order to avoid damaging your snowblower, adjust the speed of descent of your 3 point hitch to prevent striking the ground too hard.
- 8) Adjust the hydraulic flow in order to have a good control of the rotation speed of the chute.

5

---

---

# *MAINTENANCE*

---

- 1) Wipe off all grease fittings with a clean cloth before adding grease in order to avoid injecting dirt and sand.
- 2) Repair or replace damaged grease fittings.
- 3) Lubricate all grease fittings every 8 hours of operation.
- 4) Oil drive chain every 8 hours of operation.
- 5) Lubricate P.T.O. shaft as indicated below:

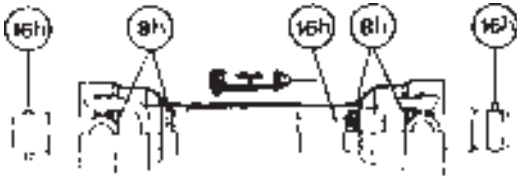

Pull out the P.T.O. and lubricate between the two tubes with high quality low temperature grease.

- 6) Check oil level in gear box once a month. Adjust to required oil level as per drawing in Parts List section. Use SAE 80W90 oil.
- 7) Check tension of drive chain every 24 hours of operation and adjust if necessary.

- 8) Check for tightness of bearing collars every 48 hours of operation.
- 9) Change gearbox oil once a year. Adjust to required oil level as per drawing in Parts List section. Use SAE 80W90 oil.
- 10) Check all nuts and bolts once a year. If necessary use torque chart on page 28.
- 11) Standard scraper blades are reversible. Reverse when one edge is worn out.
- 12) Always use recommended shear bolts.
- 13) UHMW slides do not require lubrication except at the end of the season in order to prevent corrosion of steel components that are in contact with the UHMW material.

---

---

## ***STORAGE***

---

- 1) Store the Snowblower in a cool, dry place.
- 2) Support the Snowblower with wooden blocks.
- 3) Keep all piston rods in the retracted position. This will assure better protection against the elements.
- 4) Clean your Snowblower.
- 5) Thoroughly inspect all parts of the Snowblower. Replace or repair worn or defective parts.
- 6) Touch-up or repaint if necessary.
- 7) Lubricate all points before storage.

# ***TROUBLESHOOTING***

## ***P.T.O. SHAFT***

<b>PROBLEM</b>	<b>POSSIBLE CAUSE</b>	<b>CORRECTION</b>
- Premature wear of U-joints and/or bluish color of cross journals.	- Insufficient lubrication.  - Excessive working angle.	- Follow lubrication recommendations. - Replace defective U-joints. - Make sure the snowblower inlet face is perpendicular to the ground and if possible readjust 3-point hitch in order to position the snowblower further away from tractor.
- Gripping or premature wear of telescoping members.	- Too much sliding under load.  - Tube overlap too-short: minimum recommended is 6". - Insufficient lubrication. - Contaminants (sand, etc.).	- Avoid raising snowblower while in operation. - Readjust 3-point hitch in order to position the snowblower closer to the tractor. - Follow lubrication recommendations. - Replace defective telescopic members.
- Damaged or jammed locking pin or bolt.	- Pin or orifice contaminated by sand, ice, etc. - Telescoping members too long, exerting pressure on locking device.	- Clean and grease.  - Readjust 3-point hitch in order to position the snowblower further away from tractor.
- Premature wear of guard tube bearing ring.	- Lack of lubrication. - Wrong installation of guard chain. - Part of the guard in contact with the equipment.	- Follow lubrication instructions. - Adjust chain to prevent interference between guard & equipment. - Replace worn or damaged bearing rings.
- Cut or deformed safety guard tubes.	- Tubes in contact with the equipment.	- Eliminate any interference between tubes and equipment or tractor. - Replace damaged tubes.



# ***TROUBLESHOOTING (cont'd)***

## ***SNOWBLOWER***

<b>PROBLEM</b>	<b>POSSIBLE CAUSE</b>	<b>CORRECTION</b>
- The snow is not being thrown as far as usual.	- Tractor RPM too low. - Gap too wide between impeller blade tip and drum outlet wall. - Insufficient tractor HP.	- Raise P.T.O. speed to a minimum of 540 RPM. - Adjust impeller blades closer to drum outlet (1/8" to 3/16"). - Reduce travel speed.
- Frequent plugging of discharge chute.	- Tractor RPM too low. - Tractor RPM reduced too early with snow still in the Snowblower. - Slippage of PTO clutch mechanism. - Wet snow condition.	- Raise P.T.O. speed to a minimum of 540 RPM. - Make sure the Snowblower is completely empty before reducing RPM, especially on tractors with foot controlled RPM. - Repair clutch. - Reduce travel speed. - Remove the access door.
- The impeller will not turn.	- Shear bolt broken on drive shaft.	- Replace shear bolt.
- The auger will not turn.	- Shear bolt broken on drive shaft. - Shear bolt broken on auger drive shaft. - Broken drive chain.	- Replace shear bolt. - Replace shear bolt. - Fix or replace chain.
- The rotating drum will not turn.	- Ice accumulation. - Wrong hydraulic connections.	- Remove ice. - Check hydraulic connections.
- The rotating drum will not hold it's position when blowing via the spout	- Cushion valve setting too low - Tension of the spring in drum locking mechanism insufficient	- Reset cushion valve up to 1800 psi (max) - Increase tension of spring by adding shim(s)
- The chute will not turn.	- Ice accumulation. - Wrong hydraulic connections.	- Remove ice. - Check hydraulic connections.

# ***SPECIFICATIONS***

	<b>P-860IV</b>	<b>P-920IV</b>
Horse power recommended	50 to 75 HP	
Working width	86"	92"
Cutting height	31"	
Impeller diameter	28"	
Depth of drum	12"	
Impeller blades	4 curved blades	
Number of shear bolts	1 for impeller, 1 on auger drive	
Size of impeller shaft	1.575" (40 mm)	
Impeller RPM	540 RPM	
Number of augers	1	
Drive chain	No. 80	
Scraper blade for snowblower	Std. • Standard steel (1/2" x 4")	
	Opt. • CHT-360 steel (1/2" x 4")	
	Opt. • CHT-360 steel (1/2" x 6") sharpened	
	Opt. • TIVAR 88™ (1" x 5¼")	
	Opt. • Stainless Steel (1/2" x 4")	
Rear mount scraper blade	Option	
Plow blade for rear mount scraper blade	Opt. • Standard steel	
	Opt. • TIVAR	
	Opt. • Stainless steel	
Chute	Semi-industrial chute with cylinder on the deflector	
Chute rotation mechanism	Hydraulic with motor included UHMW slide included	
P.T.O.	No. 6	
Auger bearing	1 1/2"	
Hose support	Included	
Hitch category	Category 2	
Weight (approx.)	1200 lbs	1600 lbs

Design and specifications subject to change without notice.

# SNOWBLLOWERS P-860IV P-920IV

170-04471R1

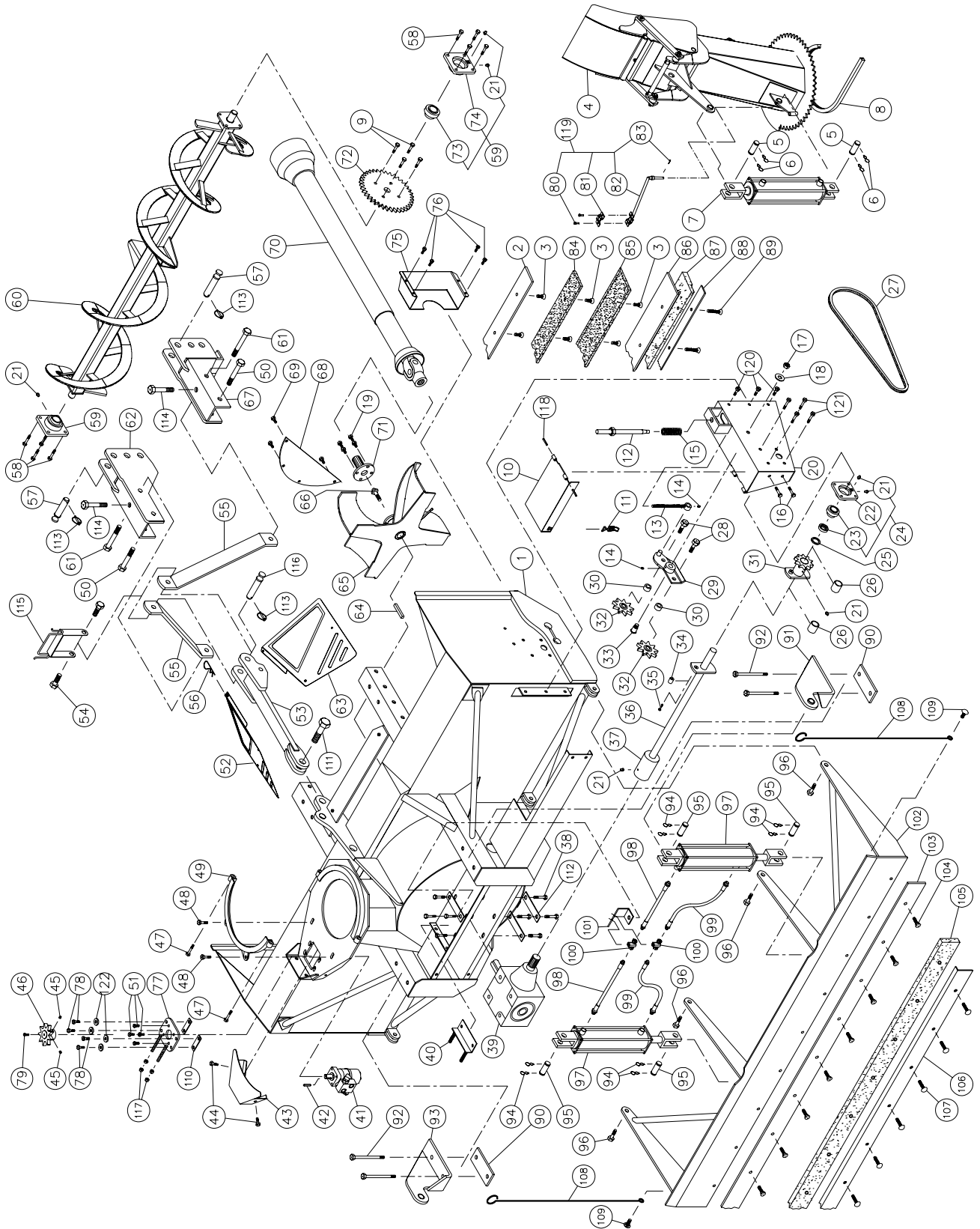

# SNOWBLOWERS P-860IV & P-920IV

REF.	PART #	DESCRIPTION	QTY	
			P-860IV	P-920IV
1	120-06701	Frame for P-860IV (from serial # 27619 and up) .....	1	-
1	120-06311	Frame for P-920IV (from serial # 27619 and up) .....	-	1
2	140-00812	Standard steel reversible scraper blade 1/2" x 4" x 84 1/2" lg .....	1	-
2	140-00832	Standard steel reversible scraper blade 1/2" x 4" x 90 1/2" lg .....	-	1
2	140-15041	Stainless steel reversible scraper blade 1/2" x 4" x 84 1/2" lg .....	opt.	-
2	140-15051	Stainless steel reversible scraper blade 1/2" x 4" x 90 1/2" lg .....	-	opt.
3	319-38310	Plow bolt 7/16" NC x 1 1/2" lg + nut & lockwasher .....	9	9
4	120-03953	Semi-industrial chute .....	1	1
5	D-600-51	Pin 1" x 3" .....	2	2
6	51472	Hitch pin clip (CP132H) .....	4	4
7	25TR08	Cylinder 2.5" x 8" standard .....	1	1
8	8149	U-shaped UHMW ± 14" i.d. ....	1	1
9	300-38310	Bolt 7/16" NC x 1 1/2" lg + two-way locknut .....	4	4
10	110-21091	Chain guard cover .....	1	-
10	110-21081	Chain guard cover .....	-	1
11	8374	Adjustable clamp fastener (welded) .....	1	1
12	110-10271	Threaded tube for idler adjustment .....	1	1
13	110-02402	Threaded rod for idler adjustment + nut 7/16" NC .....	1	1
14	Std.	Grease fitting 1/4"-28 90° .....	2	2
15	9688	Compression spring .....	1	1
16	300-38250	Bolt 7/16" NC x 1" lg + nylon locknut .....	2	2
17	346-45000	Nylon locknut 5/8" NC thin .....	1	1
18	376-44000	Flat washer 5/8" .....	1	1
19	300-38310	Bolt 7/16" NC x 1 1/2" lg + nylon locknut .....	4	4
20	110-16481	Chain guard .....	1	1
21	Std.	Grease fitting 1/4"-28 straight .....	8	8
22	FD207	Flange (for 2 grease fitting) .....	1	1
23	SAG207-20	Bearing 1 1/4" (with eccentric collar for FD207) .....	1	1
24	SAGFD207-20-C	Bearing 1 1/4" + flange & 2 grease fitting (straight) + eccentric collar .....	1	1
25	160-03942	Spacer 1 1/4" i.d. x 1 5/8" o.d. x 5/32" thick .....	1	1
26	8009	Brass bushing 1 1/4" i.d. x 1 1/2" o.d. x 1 3/16" lg .....	2	2
27	190-01401	Chain no. 80 x 71" lg (71 links) .....	1	1
28	300-46400	Bolt 3/4" NC x 3" lg + nylon locknut .....	2	2
29	110-01052	Idler .....	1	1
30	160-06511	Spacer 3/4 i.d. x 1 1/4" o.d. x 3/4" lg .....	2	2
31	8184	Sprocket 80A10 + shearplate .....	1	1
32	9287	Idler sprocket #80 .....	2	2
33	150-00332	Idler clevis pin .....	1	1
34	150-01491	Bushing 1/4" d.i. x 7/8" d.e. x 3/4" lg (welded) .....	2	2
35	300-32340	Bolt 1/4" NC x 2" lg + nylon locknut .....	1	1
36	110-18821	Auger drive shaft 32 13/16" lg overall (includes no. 34 and no.37) .....	1	-
36	110-05971	Auger drive shaft 35 13/16" lg overall (includes no. 34 and no.37) .....	-	1
37	6466	Splined adaptor 1 1/4" - 19 splines (welded) .....	1	1
38	300-40280	Bolt 1/2" NC x 1 1/4" lg + lock washer .....	8	8
39	190-01491	Gear box T27D modified .....	1	1
40	8199	Adjustment plate for gear box + 4 nuts 1/2" NC .....	1	1
41	MLH-315	Hydraulic Orbit motor with cushion valve .....	1	1
42	8369	Key for hydraulic motor .....	1	1
43	130-08162	Guard .....	1	1
44	300-38280	Bolt 7/16" NC x 1 1/4" lg + nylon locknut + flat washer .....	2	2
45	323-36160	Hexagonal socket set screw 3/8" NC x 3/8" lg .....	2	2
46	110-04182	Sprocket 9 tooth .....	1	1
47	300-38400	Bolt 7/16" NC x 3" lg + nylon locknut .....	2	2
48	300-40310	Bolt 1/2" NC x 1 1/2" lg + nylon locknut + flat washer .....	2	2
49	110-01341	Retaining bracket .....	1	1
50	302-46580	Bolt 3/4" NF x 6" lg + nylon locknut .....	2	2
51	300-36250	Bolt 3/8" NC x 1" lg + lock washer .....	4	4

# SNOWBLOWERS P-860IV & P-920IV

REF.	PART #	DESCRIPTION	QTY	
			P-860IV	P-920IV
52	110-22771	Left guard .....	1	1
53	110-15691	Upper hitch .....	1	1
54	300-46400	Bolt 3/4" NC x 3" lg + nylon locknut .....	2	2
55	140-11142	3-points side bar .....	2	2
56	Std.	Hitch pin clip 1/8" x 2 9/16" .....	7	7
57	9269	Pin category 2 .....	2	2
58	300-40325	Bolt 1/2" NC x 1 3/4" lg + nylon locknut + flat washer 7/16" .....	8	8
59	UCFD208-24	Bearing 1 1/2" + flange & 2 grease fitting (straight) .....	2	2
60	110-18831	Auger .....	1	-
60	110-02451	Auger .....	-	1
61	302-46610	Bolt 3/4" NF x 6 1/2" lg + nylon locknut .....	2	2
62	110-15681	Left lower hitch .....	1	1
63	110-22761	Right guard .....	1	1
64	9685	Key 3/8" x 3/8" x 3 11/16" lg .....	1	1
65	110-34401	Impeller 28" ø - 4 blades (from serial # 27619 and up) .....	1	1
66	190-01411	Bolt 5/8" NC x 1 1/2" lg + lock washer (ass'd with locktite 242) .....	1	1
67	110-15682	Right lower hitch .....	1	1
68	130-58731	Deflector (from serial # 27619 and up) .....	1	1
69	300-38250	Bolt 7/16" NC x 1" lg + nylon locknut .....	4	4
70	190-00471	P.T.O. shaft .....	1	1
71	110-06041	Splined adaptor 1 3/8" - 6 splines .....	1	1
72	9281	Sprocket 80A30 T 1 1/2" ø .....	1	1
73	UC208-24	Bearing 1 1/2" .....	2	2
74	FD208	Flange for 2 grease fitting .....	2	2
75	130-38702	Interior chain guard .....	1	1
76	300-36250	Bolt 3/8" NC x 1" lg + nylon locknut .....	4	4
77	110-20811	Orbit motor support .....	1	1
78	300-38310	Bolt 7/16" NC x 1 1/2" lg + nylon locknut .....	4	4
79	300-32220	Bolt 1/4" NC x 3/4" lg + lock washer .....	1	1
80	300-32250	Bolt 1/4" NC x 1" lg + nylon locknut .....	2	2
81	140-13071	Hoses mounting plate .....	1	1
82	110-01112	Mounting support plate .....	1	1
83	Std.	Cotter pin 1/8" x 1" .....	1	1
84	140-04081	Scraper blade (hardened steel, not sharpened, reversible) 1/2" x 4" x 84 1/2" lg ...	opt.	-
84	140-04091	Scraper blade (hardened steel, not sharpened, reversible) 1/2" x 4" x 90 1/2" lg ...	-	opt.
85	140-04141	Scraper blade (hardened steel, sharpened, not reversible) 1/2" x 6" x 84 1/2" lg ...	opt.	-
85	140-04151	Scraper blade (hardened steel, sharpened, not reversible) 1/2" x 6" x 90 1/2" lg ...	-	opt.
86	110-10391	TIVAR scraper blade holder 3/8" x 5 1/2" x 84 1/2" lg .....	opt.	-
86	110-10381	TIVAR scraper blade holder 3/8" x 5 1/2" x 90 1/2" lg .....	-	opt.
87	190-01331	TIVAR scraper blade 1" x 84 1/2" lg .....	opt.	-
87	190-01321	TIVAR scraper blade 1" x 90 1/2" lg .....	-	opt.
88	140-03991	TIVAR scraper blade support 1/4" x 2" x 84 1/2" lg .....	opt.	-
88	140-03981	TIVAR scraper blade support 1/4" x 2" x 90 1/2" lg .....	-	opt.
89	319-38370	Plow bolt 7/16" NC x 2 1/2" lg + nut & lock washer (9) .....	opt.	opt.
90	140-07881	Support plate (2) .....	opt.	opt.
91	110-10244	Cylinder fastener (right side) .....	opt.	opt.
92	300-44550	Bolt 5/8" NC x 5 1/2" lg + nylon locknut (4) .....	opt.	opt.
93	110-10243	Cylinder mounting attachment (left side) .....	opt.	opt.
94	51472	Hairpin cotter (CP132H) (8) .....	opt.	opt.
95	D-600-51	Pin 1" x 3" lg (4) .....	opt.	opt.
96	300-46370	Bolt 3/4" NC x 2 1/2" lg + nylon locknut (4) .....	opt.	opt.
97	25TR08	Cylinder 2 1/2" x 8" standard (2) .....	opt.	opt.
98	190-02591	Hose 3/8" x 16 1/2" lg + 2 fittings 6U106 (2) .....	opt.	opt.
99	190-02581	Hose 3/8" x 19" lg + 2 fittings 6U106 (2) .....	opt.	opt.
100	5856x6x6	«T» 3/8" NPT (2) .....	opt.	opt.
101	130-30421	Hose support .....	opt.	opt.
102	110-18811	Rear mount scraper blade frame .....	opt.	-

# SNOWBLOWERS P-860IV & P-920IV

REF.	PART #	DESCRIPTION	QTY	
			P-860IV	P-920IV
102	110-08341	Rear mount scraper blade frame .....	-	opt.
103	140-12021	Plow blade (standard steel, reversible) 3/8" x 4" x 85" lg .....	opt.	-
103	140-11171	Plow blade (standard steel, reversible) 3/8" x 4" x 91" lg .....	-	opt.
103	140-15271	Plow blade (stainless steel, reversible) 3/8" x 4" x 85" lg .....	opt.	-
103	140-15281	Plow blade (stainless steel, reversible) 3/8" x 4" x 91" lg .....	-	opt.
104	319-38310	Plow bolt 7/16" NC x 1 1/2" lg + nut & lock washer (9/860) (11/920) .....	opt.	opt.
105	190-04721	TIVAR plow blade 1" x 4" x 85" lg .....	opt.	-
105	190-02172	TIVAR plow blade 1" x 4" x 91" lg .....	-	opt.
106	130-24501	TIVAR plow blade support 84 1/4" lg .....	opt.	-
106	130-09072	TIVAR plow blade support 90 1/4" lg .....	-	opt.
107	321-38355	Carriage bolt 7/16" NC x 2 1/4" lg + nut & lock washer (9/860) (11/920) .....	opt.	opt.
108	190-02193	Proximity indicator (2) .....	opt.	opt.
109	321-40310	Carriage bolt 1/2" NC x 1 1/2" lg + nylon locknut (2) .....	opt.	opt.
110	140-09571	Spacer 1/8" x 1" x 4 1/2" lg + nylon locknut .....	2	2
111	300-54460	Bolt 1 1/4" NC x 4" lg + nylon locknut .....	1	1
112	140-10571	Back plate .....	3	3
113	Std.	Lynch pin 1/4" x 1 3/4" .....	3	3
114	302-46520	Bolt 3/4" NF x 5" lg + nylon locknut .....	2	2
115	110-15201	Hoses support .....	1	1
116	150-05961	Pin category 2 (1" diameter) (top link) .....	1	1
117	336-38000	Nut 7/16" NC .....	4	4
118	Std.	Roll pin 5/16" x 2" .....	2	2
119	TSB-74104	Hoses support for deflector cylinder .....	opt.	opt.
120	300-38250	Bolt 7/16" NC x 1" lg + nylon locknut & flat washer 3/8" .....	3	3
121	300-38310	Bolt 7/16" NC x 1 1/2" lg + nylon locknut + flat washer 3/8" .....	4	4
122	150-12741	Flat washer .....	4	4

# SEMI-INDUSTRIAL CHUTE PSIG-7486IV

170-03523

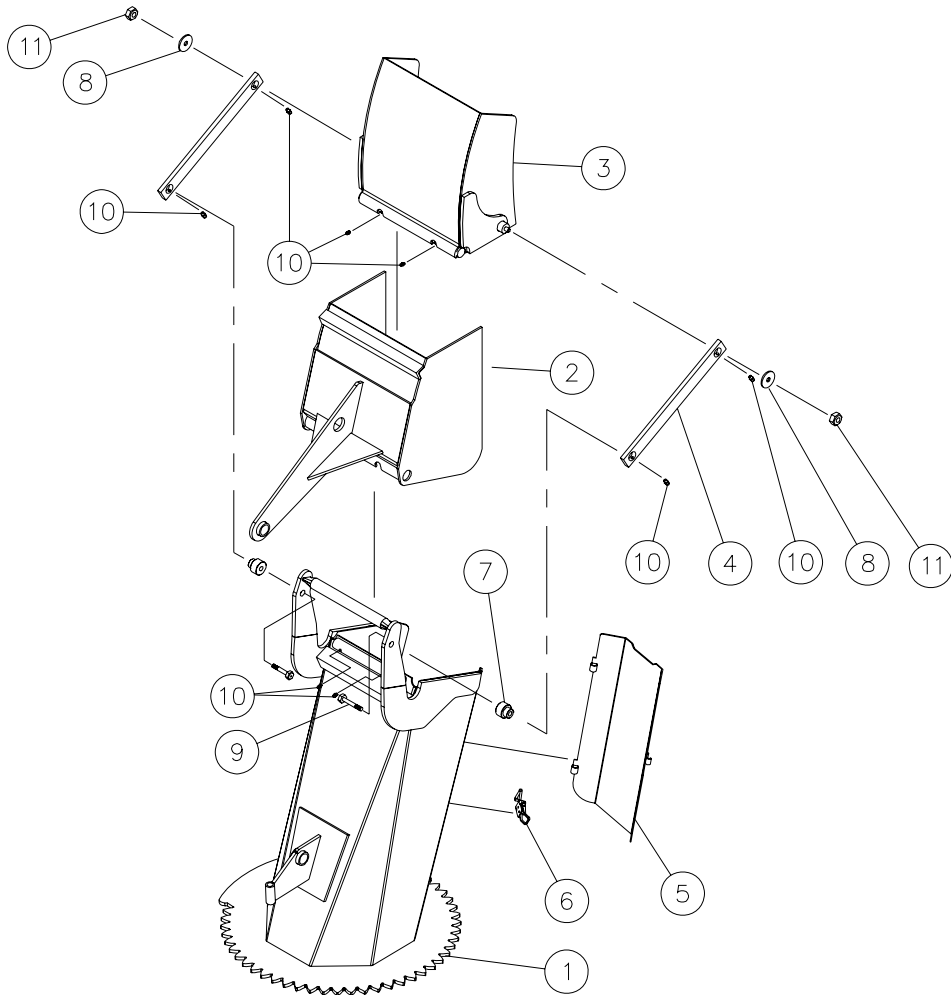

REF.	PART #	DESCRIPTION	QTY
1	110-22853	Chute base .....	1
2	110-22521	Lower chute deflector .....	1
3	110-22511	Upper chute deflector .....	1
4	140-14041	Connecting rod .....	2
5	130-22893	Access panel.....	1
6	8376	Adjustable clamp fastener (welded) .....	1
7	150-05311	Spacer for connecting rod .....	2
8	378-36500	Washer .....	2
9	300-40380	Bolt 1/2" NC x 2 3/4" lg + nylon locknut & washer .....	2
10	Std.	Grease fitting 1/4"-28 straight .....	8
11	346-37000	Écrou à blocage de nylon 3/8" NC .....	2

# P.T.O. SHAFT # 190-00471 (T60)

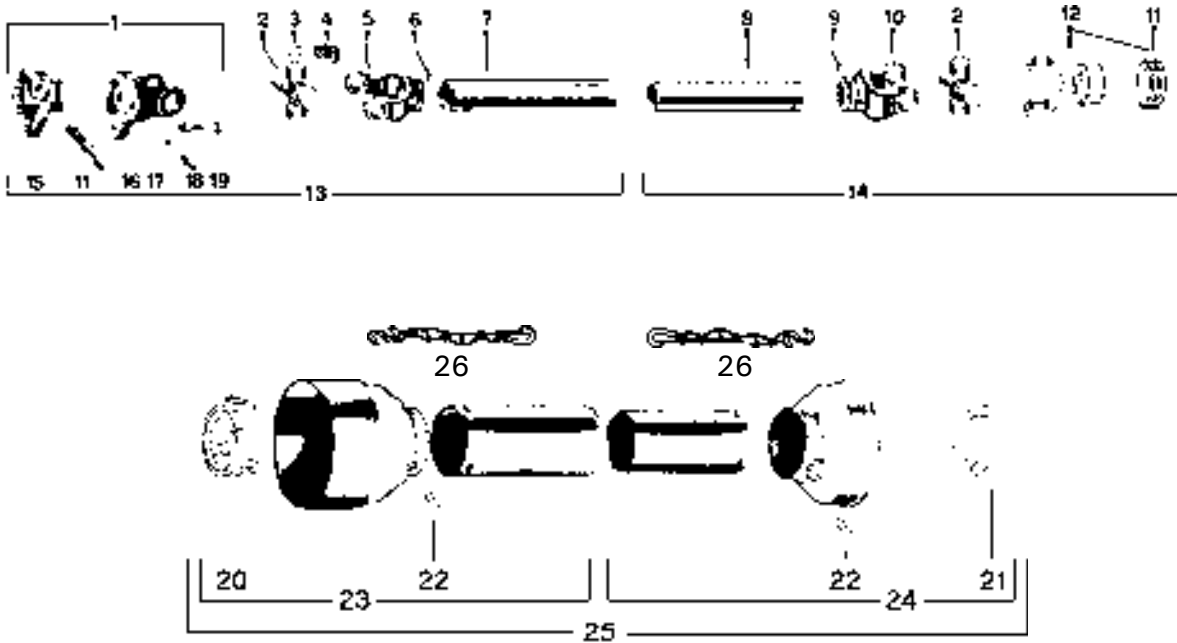

REF.	PART #	DESCRIPTION	QTY
1	8237-1	Safety shear yoke .....	1
2	8238	U joint + 4 retaining rings + 1 grease fitting .....	2
3	8061	Retaining ring .....	8
4	8110	Grease fitting .....	2
5	8240	Yoke for outer tube .....	1
6	9210-E	Stopper for outer tube .....	1
7	9212-121	Outer tube .....	1
8	8077-121	Inner tube .....	1
9	8075	Stopper for inner tube .....	1
10	8239	Yoke for inner tube .....	1
11	8363	Collar kit .....	2
12	8250	Yoke with hole 1 3/8"-6 splines + yoke stopper (#11 included) .....	1
13	8241-1-121	P.T.O. section, side with safety shear bolt, outer part, with protector .....	1
14	8242-121	P.T.O. section, side without safety shear bolt, inner part, with protector .....	1
15	8243-1	Adaptor with yoke stopper .....	1
16	8244	Yoke and shearplate .....	1
17	9205	Ball .....	17
18	8071	Grease fitting .....	1
19	8218	Safety shear bolt M10 x 60mm .....	1
20	8246	Bearing ring for outer guard tube .....	1
21	8245	Bearing ring for inner guard tube .....	1
22	8109	Stopper .....	6
23	8248-121	Outer shield .....	1
24	8247-121	Inner shield .....	1
25	8249-121	Complete shield .....	1
26	8303	Safety chain .....	2



# GEAR BOX # 190-01491 (T27D modified)

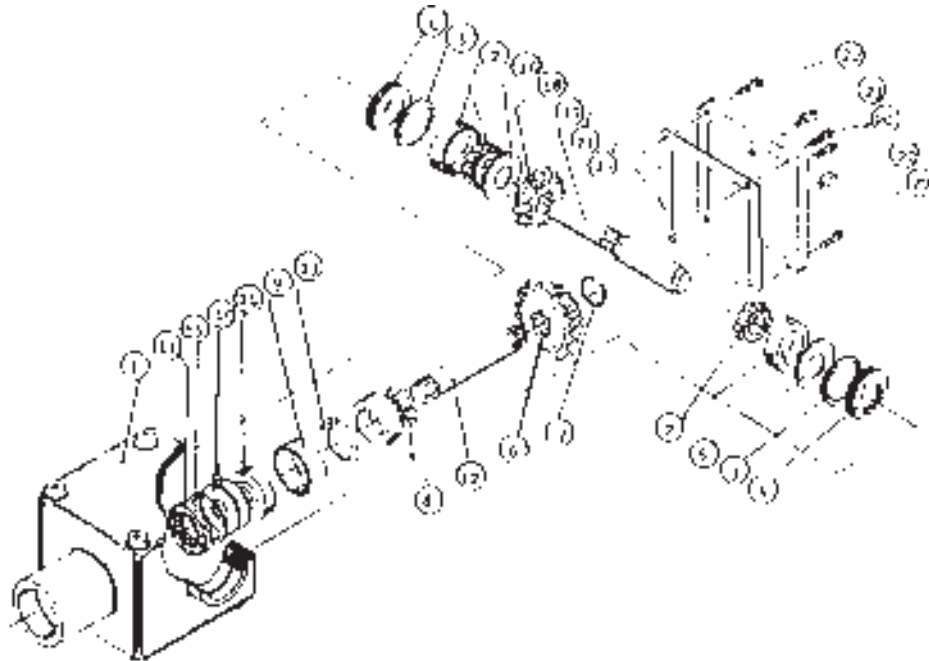

REF.	PART #	DESCRIPTION	QTY
1	8043	Casing .....	1
2	30208-A	Roller bearing .....	2
3	8045	Inside circlip 80mm .....	2
4	8046	Oil seal 40 x 80 x 12mm .....	2
5	8047	Adjusting washer .....	1
6	8048	Gear Z18 .....	1
7	8049	Outside circlip 40mm .....	1
8	30207-A	Roller bearing .....	1
9	8051	Spacer ring .....	1
10	8052	Adjusting washer .....	2
11	8053	Oil seal 35 x 72 x 12mm .....	1
12	8054	Side shaft (1 ¼" - 19 splines) .....	1
13	8055	Inside circlip 72mm .....	1
14	6207-2RS	Ball bearing .....	1
15	8057	Outside circlip 35mm .....	1
16	8058	Adjusting washer .....	1
17	190-01492	Impeller shaft 1.575" .....	1
18	8060	Gear Z-18 .....	1
19	---	Use silicone caulking .....	-
20	8062	Bolt M10 x 14mm .....	4
21	8063	Cover .....	1
22	8064	<b>Oil level plug</b> .....	1
23	8065	Vent plug .....	1

# CYLINDER 25TR08

15050

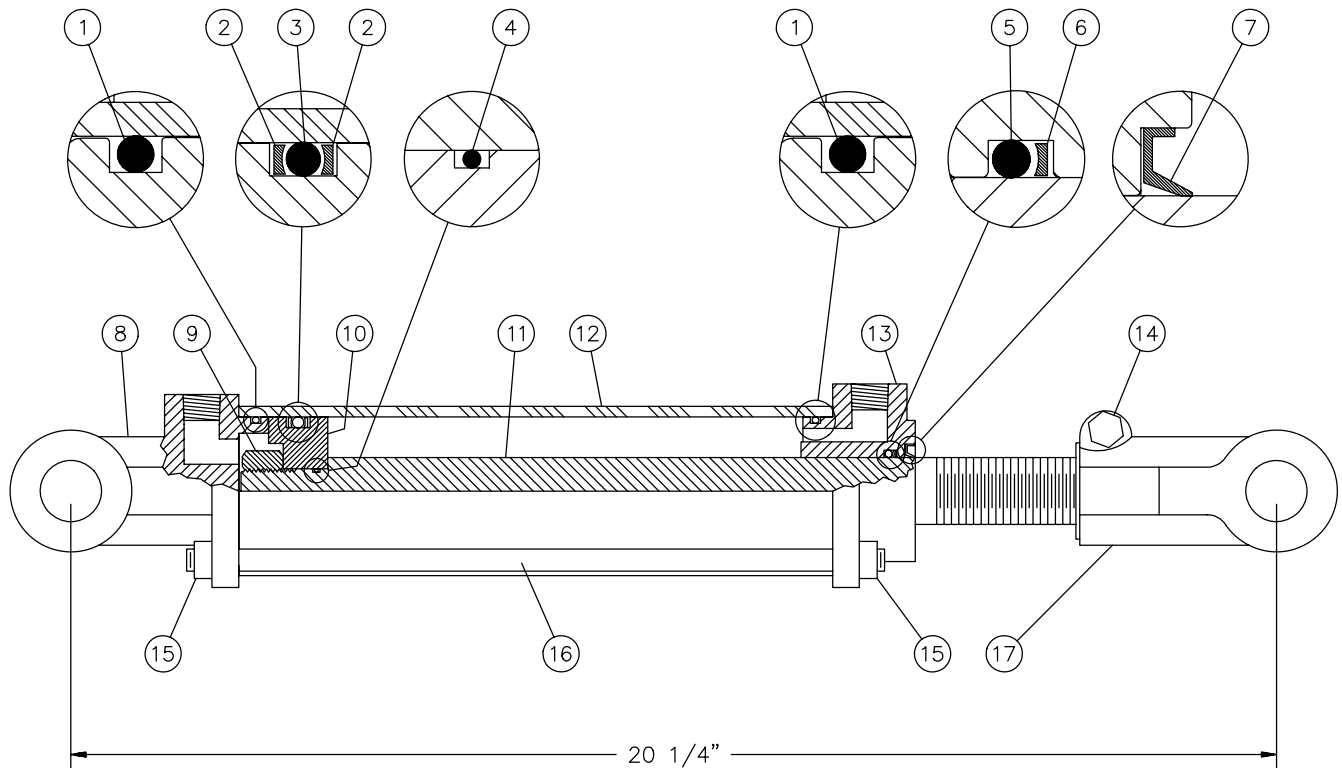

REF.	PART #	DESCRIPTION	QTY
1	See #RK25TR	O-ring 1/8" x 2 1/4" x 2 1/2" .....	2
2	See #RK25TR	Back-up 2 1/2" o.d. x 3/16 ø .....	2
3	See #RK25TR	O-ring 3/16" x 2 1/8" x 2 1/2" .....	1
4	See #RK25TR	O-ring 1/16" x 5/8" x 3/4" .....	1
5	See #RK25TR	O-ring 1/8" x 1 1/8" x 1 3/8" .....	1
6	See #RK25TR	Back-up 1 3/8" o.d. x 1/8" ø .....	1
7	See #RK25TR	Wiper 1 1/8" i.d. x 1 5/8" o.d. ....	1
8	492401	Yoke (for 2 1/2" tube) .....	1
9	338-46000	Nut 3/4" NF .....	1
10	4924-31	Piston 2 1/2" ø .....	1
11	491980	Piston rod 1 1/8" .....	1
12	491668	Cylinder body 2 1/2" ø .....	1
13	492421	Head (for 2 1/2" tube) .....	1
14	300-36355	Bolt 3/8" NC x 2 1/4" + nut .....	1
15	336-36000	Nut 3/8" NC .....	8
16	Std.	Threaded rod 3/8" NC x 12" lg .....	4
17	458599	Yoke (for 1 1/8" rod) .....	1
NI*	8183	Pin 1" ø + cotter pin .....	2
NI*	RK25TR	Repair kit for cylinder 2 1/2" (includes # 1, 2, 3, 4, 5, 6, & 7) .....	1

\*NI = NOT ILLUSTRATED

# HYDRAULIC MOTOR MLH-315

CUSHION VALVE  
H110



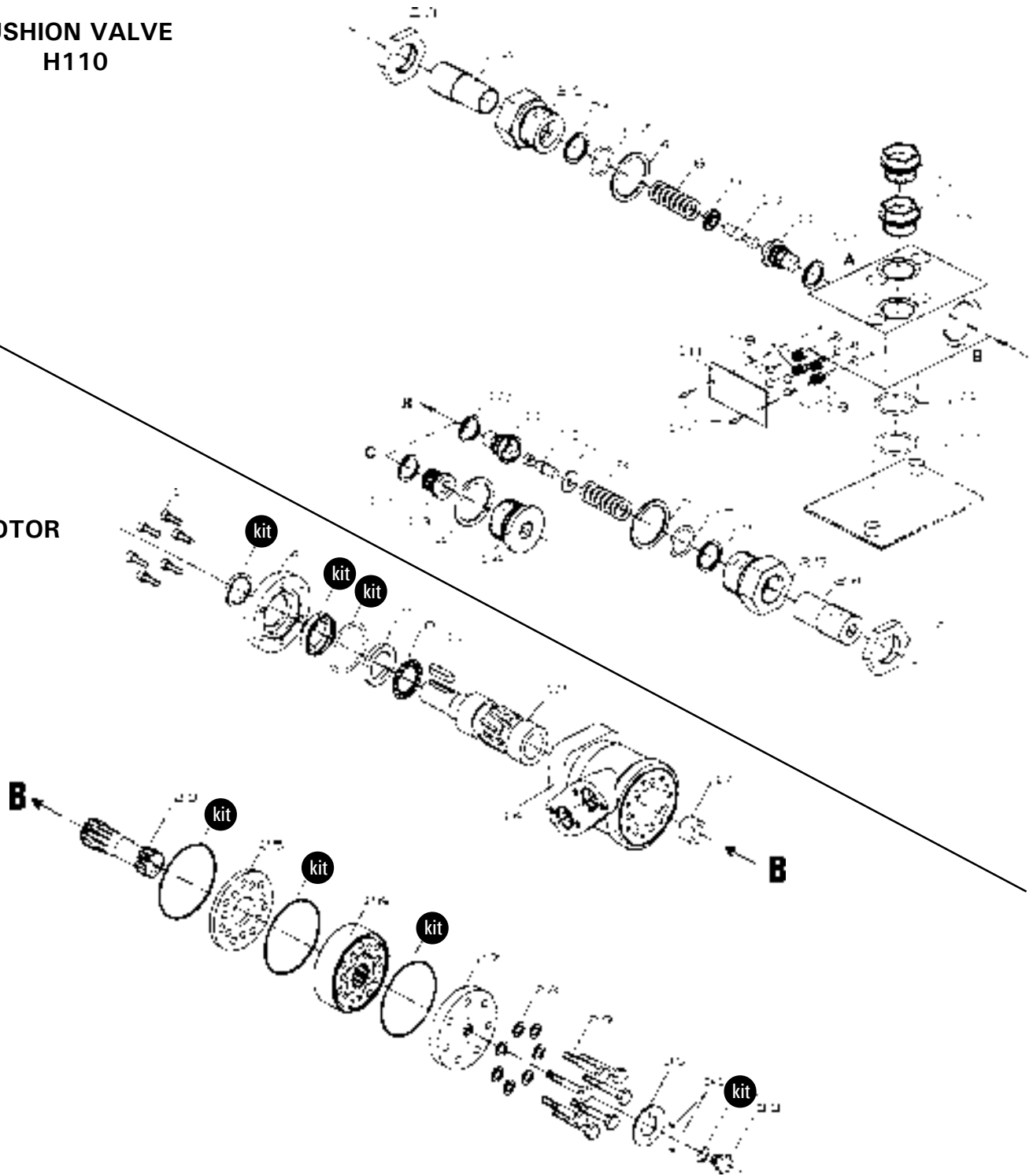



MOTOR







REF.	PART #	DESCRIPTION	QTY
kit	8368	Set of seals.....	1
11	8369	Key for "Orbit" motor.....	1

# TORQUE CHART

## TORQUE SPECIFICATION TABLE

Thread UNC and UNF		Grade 2 				Grade 5   				Grade 8*   			
Bolt size		Torque				Torque				Torque			
Inches	mm	Pound feet min.	max.	Newton meters min.	max.	Pound feet min.	max.	Newton meters min.	max.	Pound feet min.	max.	Newton meters min.	max.
1/4	6.35	5	6	6.8	8.13	9	11	12.2	14.9	12	15	16.3	30.3
5/16	7.94	10	12	13.6	16.3	17	20.5	23.1	27.8	24	29	32.5	39.3
3/8	9.53	20	23	27.1	31.2	35	42	47.5	57.0	45	54	61.0	73.2
7/16	11.11	30	35	40.7	47.4	54	64	73.2	86.8	70	84	94.9	113.9
1/2	12.70	45	52	61.0	70.5	80	96	108.5	130.2	110	132	149.2	179.0
9/16	14.29	65	75	88.1	101.6	110	132	149.2	179.0	160	192	217.0	260.4
5/8	15.88	95	105	128.7	142.3	150	180	203.4	244.1	220	264	298.3	358.0
3/4	19.05	150	185	203.3	250.7	270	324	366.1	439.3	380	456	515.3	618.3
7/8	22.23	160	200	216.8	271.0	400	480	542.4	650.9	600	720	813.6	976.3
1	25.40	250	300	338.8	406.5	580	696	786.5	943.8	900	1080	1220.4	1464.5
1 1/8	25.58	-	-	-	-	800	880	1084.8	1193.3	1280	1440	1735.7	1952.6
1 1/4	31.75	-	-	-	-	1120	1240	1518.7	1681.4	1820	2000	2467.9	2712.0
1 3/8	34.93	-	-	-	-	1460	1680	1979.8	2278.1	2380	2720	3227.3	3688.3
1 1/2	38.10	-	-	-	-	1940	2200	2630.6	2983.2	3160	3560	4285.0	4827.4

\* Thick nuts must be used with grade 8 bolts.

Size of screw	Thread	Pitch (mm)	Grade 4T  				Grade 7T 				Grade 8T  			
			Torque				Torque				Torque			
			Pound feet min.	max.	Newton meters min.	max.	Pound feet min.	max.	Newton meters min.	max.	Pound feet min.	max.	Newton meters min.	max.
M6	UNC	1.00	3.6	5.8	4.9	7.9	5.8	9.4	7.9	12.7	7.2	10	9.8	13.6
M8	UNC	1.25	7.2	14	9.8	19	17	22	23	29.8	20	26	27.1	35.2
M10	UNC	1.5	20	25	27.1	33.9	34	40	46.1	54.2	38	46	51.5	62.3
M12	UNC	1.75	28	34	37.9	46.1	51	59	69.1	79.9	57	66	77.2	89.4
M14	UNC	2.0	49	56	66.4	75.9	81	93	109.8	126	96	109	130.1	147.7
M16	UNC	2.0	67	77	90.8	104.3	116	130	157.2	176.2	129	145	174.8	196.5
M18	UNC	2.0	88	100	119.2	136	150	168	203.3	227.6	175	194	237.1	262.9
M20	UNC	2.5	108	130	146.3	176.2	186	205	252	277.8	213	249	288.6	337.4
M8	UNF	1.0	12	17	16.3	23	19	27	25.7	36.6	22	31	29.8	42
M10	UNF	1.25	20	29	27.1	39.3	35	47	47.4	63.7	40	52	54.2	70.5
M12	UNF	1.25	31	41	42	55.6	56	68	75.9	92.1	62	75	84	101.6
M14	UNF	1.5	52	64	70.5	86.7	90	106	122	143.6	107	124	145	168
M16	UNF	1.5	69	83	93.5	112.5	120	138	162.6	187	140	158	189.7	214.1
M18	UNF	1.5	100	117	136	158.5	177	199	239.8	269.6	202	231	273.7	313
M20	UNF	1.5	132	150	178.9	203.3	206	242	279.1	327.9	246	289	333.3	391.6

Use the above torques when special torque is not given.

NOTE: These values apply to fasteners as received from supplier, dry, or when lubricated with normal engine oil. They do not apply if extreme pressure lubricants are used.

---

---

# WARRANTY

---

PRONOVOST warrants this product to the initial purchaser for the period of one year from the date of purchase against defects in materials and workmanship.

We will replace or repair defective parts free of charge if they are returned to our plant in St-Tite, Quebec, Canada.

Transportation charges are the responsibility of the customer. This warranty is not transferable.

Hydraulic cylinders are covered by the manufacturer of these items.

The PTO shafts are warranted by the manufacturer and cover **only** defects in material and workmanship, and is conditional to recommended use and installation only.

All PRONOVOST spare parts purchased are covered by a three (3) month warranty.

This warranty becomes void and nul if the equipment is modified, breaks down as the result of an accident, is not operated according to manufacturer's recommendations, damaged by negligence or if maintenance has not been carried out as specified.

Our obligation is limited to the replacement or repair of the defective part. PRONOVOST accepts no responsibility for direct or indirect consequential damages of any kind.





Ce manuel est aussi disponible en français.  
Veuillez téléphoner.



**INNOVATION - EXCELLENCE**

**LES MACHINERIES PRONOVOST INC.**

260, route 159,

Saint-Tite, Quebec, Canada, G0X 3H0

Tel.: (418) 365-7551, Fax: (418) 365-7954

[www.pronovost.qc.ca](http://www.pronovost.qc.ca)