



PULMIC®

TAKE CONTROL

**NEW
DESIGN**

UBV / ULV
CONTROL LOCALIZADO DE MALAS HIERBAS
LOCALISED WEED CONTROL

LÍDERES
MUNDIALES
WORLDWIDE
LEADERS



Calidad Europea
European Quality



Hecho en España
Made in Spain



Aplicación con herbicidas
Herbicide application



AGRICULTURE



PULMIC[®]
TAKE CONTROL

Grupo Sanz presenta el innovador sistema Fenix, la última tecnología en técnicas de aplicación para herbicidas sistémicos. La solución más segura, eficaz, cómoda y rápida del mercado.

The Sanz Group presents the innovative Fenix system, the latest technology in application techniques for systemic herbicides. The most safe, effective, comfortable and fastest solution in the market.

SEGURIDAD
Safety

AHORRO
Saving

RAPIDEZ
Speed

EFICACIA
Effectiveness

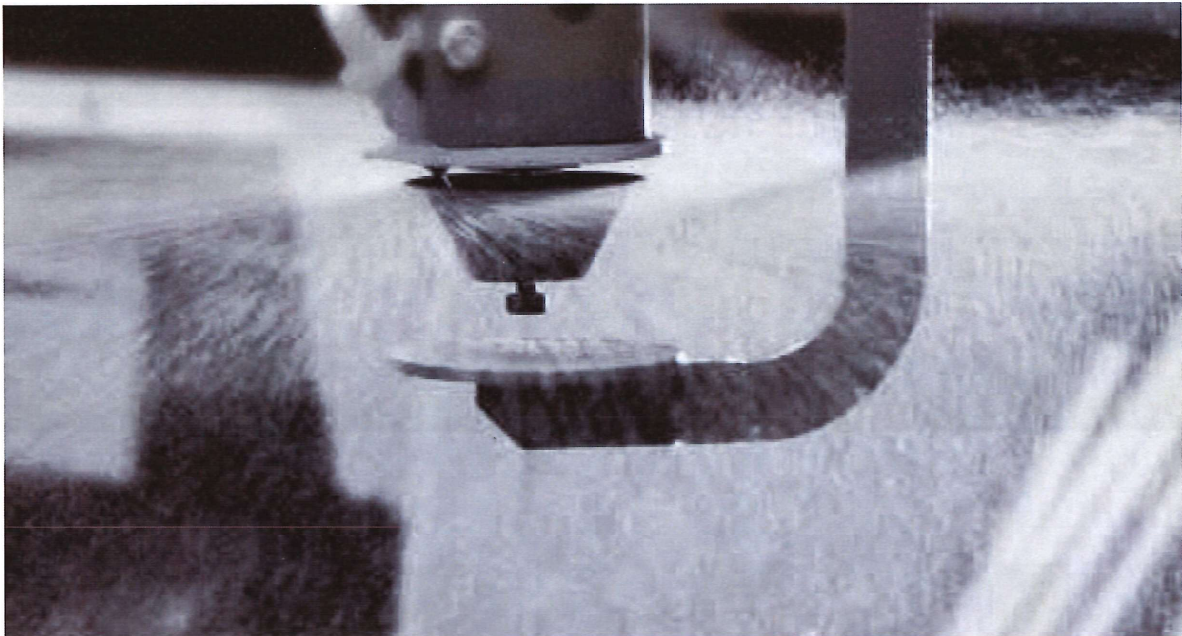

PULMIC FENIX



► **¿QUÉ ES EL ULTRA BAJO VOLUMEN Y CÓMO FUNCIONA?**

El UBV es un sistema de pulverización ideal para la aplicación de herbicidas sistémicos que distribuye las gotas de una forma homogénea y eficiente.

La pulverización UBV dispone de un disco giratorio que funciona a elevadas revoluciones, rompiendo la gota uniformemente. Fig [1]

WHAT IS ULTRA LOW VOLUME AND HOW DOES IT WORK?

The ULV is an ideal spraying system for Systemic Herbicides' application that distributes the droplet in a homogeneous and efficient way.

The ULV spraying has a rotating disc that operates at high revolutions, breaking the droplets uniformly. Fig [1]

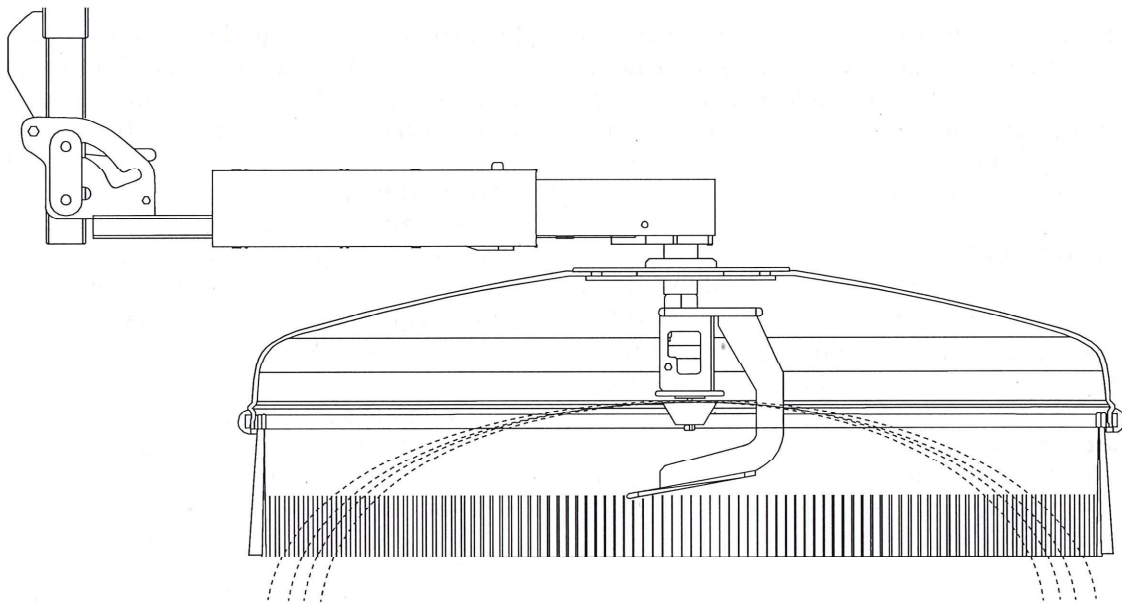

Fig [1]

Esquema del funcionamiento del sistema UBV / ULV system functioning outline

► **TABLA COMPARATIVA / COMPARATIVE TABLE**

CARACTERÍSTICA CHARACTERISTIC	UBV ULV	PULVERIZACIÓN CONVENCIONAL CONVENTIONAL SPRAYING
TAMAÑO DE GOTA DROPLET SIZE	200-300 µm	80-400 µm
L/ha	10-40 L/ha	200-400 L/ha
DERIVA / DRIFT	Sin deriva No drift	Con deriva With drift



▶ VENTAJAS

MÁXIMA SEGURIDAD

- **Sistema de aplicación dirigida y protegida:**
El sistema de aplicación dirigido y protegido mediante campanas circulares de 50cm, 80cm y 120cm, garantiza el total aislamiento de la zona tratada, permitiendo pulverizar en cualquier época del año, incluso en condiciones de viento moderado.

Máxima seguridad en las aplicaciones de primavera-verano en viña y frutales. Posibilidad de tratar en cualquier momento del año, en parada invernal o desde la brotación de las yemas hasta la cosecha, con la máxima seguridad del cultivo.

- **Brazos retráctiles:**
El sistema de brazos retráctiles facilita tratar la línea de plantación salvando suavemente el tronco o la cepa, sin dañarlo y permitiendo incluso el tratamiento en plántones jóvenes.
- **Rápidos síntomas visuales:**
Gracias a la aplicación ULV podemos ver con anticipación los síntomas en las hierbas tratadas. Incluso las más difíciles.

Fig [2]

MÁXIMA EFICACIA

El sistema de pulverización centrífuga rompe la gota de una forma controlada generando un tamaño óptimo de gota (250 micras), para la aplicación de los principales herbicidas sistémicos.

Fig [3]

MÁXIMO AHORRO

- **Elimina tiempos muertos.**
- **Ahorra combustible.**

ADVANTAGES

MAXIMUM SECURITY

- **Directed and protected application system:**
This application system is directed and protected by 50cm, 80cm and 120cm diameter's hoods, guaranteeing the total isolation of the treated area, allowing to spray at any time of the year, even under moderate wind conditions.

Maximum safety in spring-summer applications in vineyards and fruit trees. It is possible to treat your crops during the whole year, with maximum crop safety.

- **Retractable arms:**
The retractable arms system facilitates the treatment of the planting line by soft saving the tree stem or vineyard stump without damaging them and even allowing treatment in young seedlings.
- **Quick visual symptoms:**
Thanks to the ULV application we can see in advance the symptoms in the treated weeds. Even on the most difficult.

Fig [2]

MAXIMUM EFFECTIVENESS

The centrifugal spraying system breaks the droplet in a controlled manner, generating an optimal droplet size (250 microns), capable to be used with the main systemic herbicides in the market.

Fig [3]

MAXIMUM SAVING

- **Less downtime.**
- **Fuel saving.**

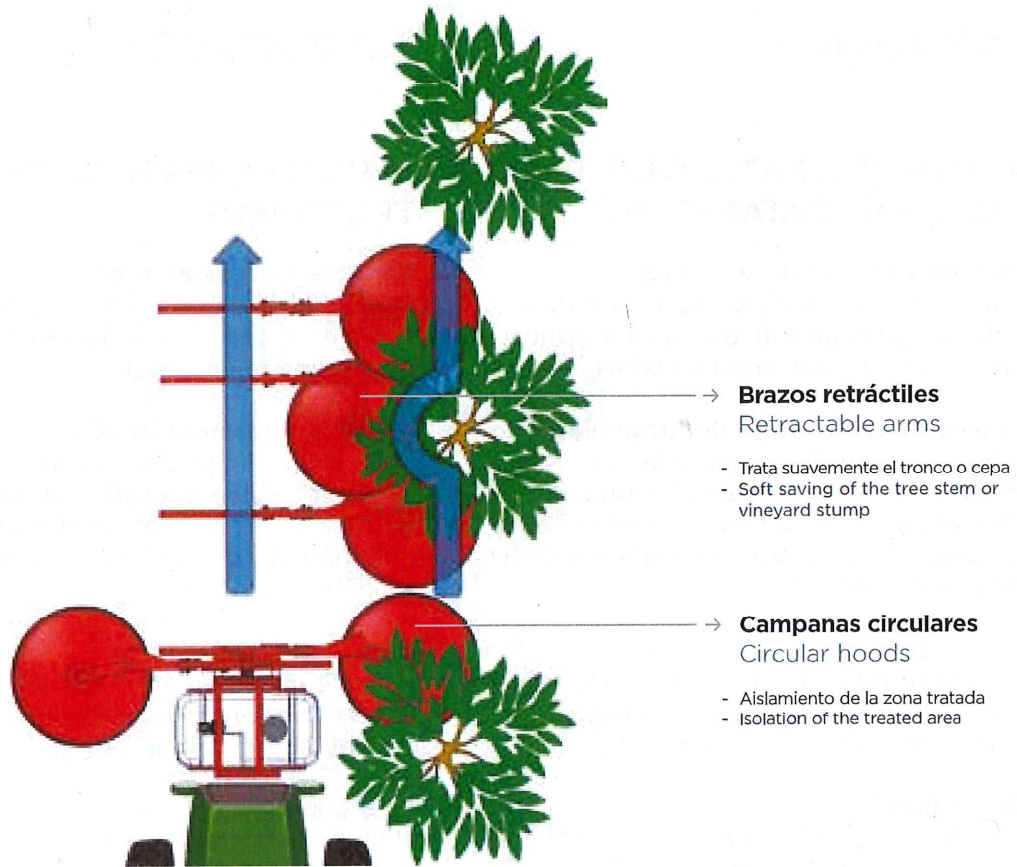

Fig [2]

Máxima seguridad en la aplicación / Maximum security application

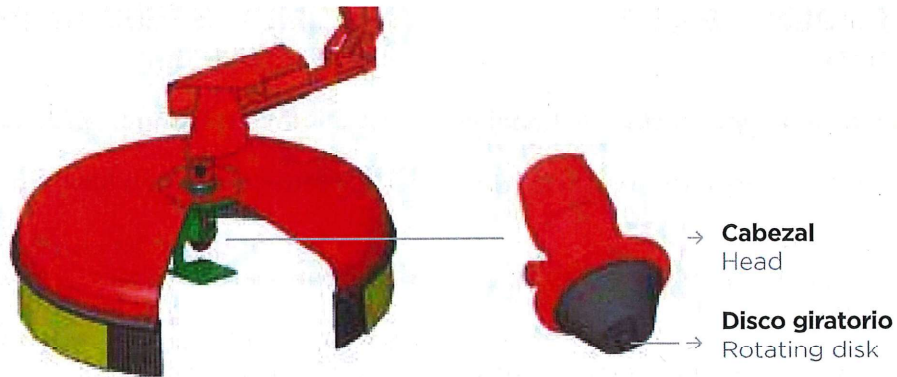

Fig [3]

Máxima eficacia / Maximum effectiveness



► VENTAJAS

MÁXIMA VERSATILIDAD PARA CUALQUIER TRATAMIENTO

- **Ángulo de tratamiento variable:**
Gracias a los brazos, es fácil cambiar el ángulo de aplicación de las campanas, incluso se puede aplicar en mesetas.
- **Modificación de la altura del tratamiento:**
El cilindro frontal, conectado al sistema hidráulico del tractor permite una rápida modificación de la altura de tratamiento, adaptándose a cualquier terreno (solo modelo para Tractor).
- **Brazo telescópico:**
Facilita la regulación en anchura, de forma rápida y sencilla que permite la adaptación a cualquier marco de plantación.
- **Fácil instalación:**
Pulmic Fenix es fácil de instalar gracias a su peso reducido. Además, se conecta directamente a la batería sin necesidad de toma de fuerza.

Fig [4]

MÁXIMA RAPIDEZ EN LA APLICACIÓN

Autonomía y mayor tiempo efectivo de trabajo:

- Reducción del tiempo de llenado del depósito.
- Solo 20L de caldo/ha frente a los 200L en pulverización convencional.
- Reduce tiempos de desplazamiento entre punto de abastecimiento y área a tratar.

Fig [5]

ADVANTAGES

MAXIMUM VERSATILITY FOR ANY TREATMENT

- **Variable treatment angle:**
Thanks to the arms, it is easy to change the angle of application of the hoods, it can even be applied on plateaus.
- **Variable treatment height:**
The front cylinder connected to the hydraulic system of the tractor, allows a rapid modification of the treatment height, adapting it to any terrain (only at Tractor model).
- **Telescopic arm:**
It facilitates the width regulation, in a fast and simple way, that allows the adaptation to any plantation frame.
- **Easy installation:**
Thanks to its lightness, this system is easy to be installed. Energy is also easy to be taken directly from the battery, connecting the power set cables.

Fig [4]

MAXIMUM SPEED IN THE APPLICATION

Autonomy and longer effective work time:

- Time reduction when filling the tank.
- Only 20L of broth/ha compared to 200L in conventional spraying.
- Saving time shifting from water supply point to treated area.

Fig [5]



PULMIC.
TAKE CONTROL

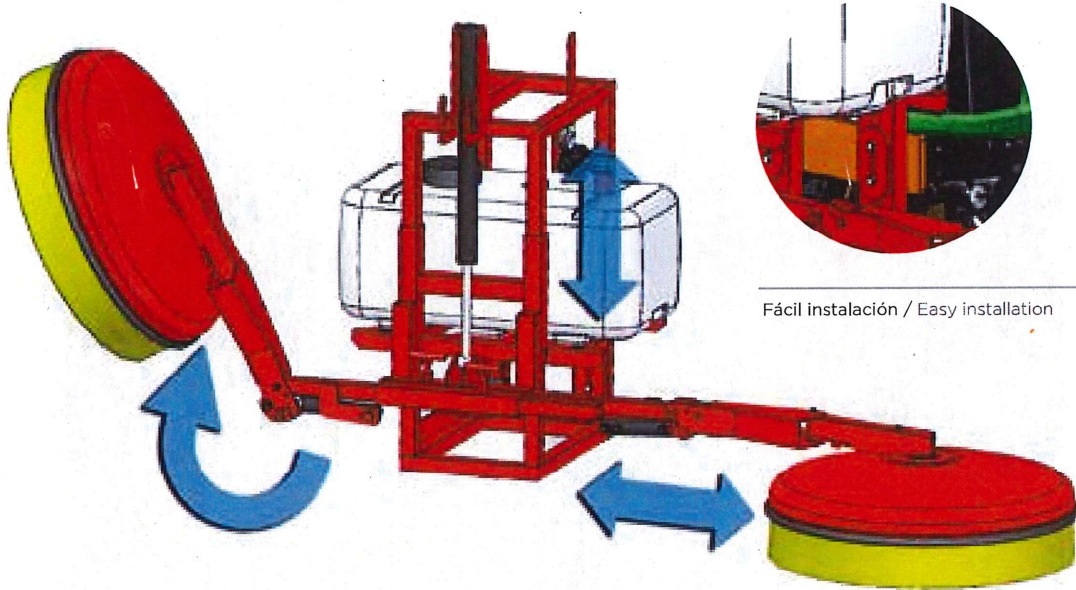

Fácil instalación / Easy installation

Fig [4]



Ángulo y altura variable / Variable angle and height



Brazo telescópico / Telescopic arm



Fig [5]

Máxima rapidez / Maximum speed

PULMIC FENIX





PULMIC.
TAKE CONTROL

PULMIC FENIX 75/100



Los pulverizadores para la aplicación de herbicidas sistémicos Pulmic Fenix 75/100, están diseñados para uso recomendado sobre quad, aunque también se pueden acoplar a otros vehículos como por ejemplo ATV o Pick-Up. Ideal para plantaciones de viña. Este modelo tiene la posibilidad de trabajar con una o dos campanas protectoras a los lados, tanto de 50cm como de 80cm de diámetro, evitando así la deriva en todo momento.

The Pulmic Fenix 75/100 ULV sprayers, are designed and recommended to be mounted on quad or on other vehicles such as ATV or Pick-Up's, Ideal for vineyard, this model has the possibility to be used with one or two hoods on the sides; with both 50cm or both 80cm avoiding the drift.





► **RECOMENDACIONES / RECOMMENDATIONS**

Cultivos / Crops	Viña / Vineyard
Marco de plantación / Plantation framework	Entre/Between 1,5 - 3 m
L/ha	15 - 40 L/ha
Velocidad / Speed	3 - 5 km/h

► **HAZ TU COMPOSICIÓN / MAKE YOUR COMPOSITION**

DEPÓSITO Tank		IZQUIERDA Left	DERECHA Right	CAJA DE CONTROL / CABLES DE ALIMENTACIÓN / CAMPANA+BRAZO Control panel for debit / Set of power cables / Hood+arm
<p>75L Ref. 10620</p> 	<p>100L Ref. 10953</p> 	<p>Ø 50cm Ref. 10613</p>	<p>Ø 50cm Ref. 10614</p>	
		<p>Ø 80cm Ref. 10615</p>	<p>Ø 80cm Ref. 10616</p>	

► **KIT ADAPTADOR / ADAPTER KIT**

Ref. 11810	
------------	--

* Necesario para acoplar las campanas con otros depósitos / It is necessary for couple the hoods with other tanks



PULMIC.
TAKE CONTROL

PULMIC FENIX COMPACT 100



El pulverizador Pulmic Fenix Compact 100, es de uso exclusivo para tractor. Gracias a su control hidráulico frontal, se puede regular la altura de las campanas desde dentro de la cabina. Este pulverizador es el más versátil de la gama ya que puedes realizar diferentes combinaciones de campanas. Es ideal para viña y para los frutales de hueso capaces de ser tratados con herbicidas sistémicos.

The Pulmic Fenix Compact 100 sprayer was designed exclusively to be used in a tractor. Thank's to it, you can reach the most adaptable hoods' combination according to your crops' needs. Appart from vineyards, this equipement is ideal for new trellis-plantation tendency on stone-fruits' and olive trees. As well as traditional plot frames of stone-fruits, olive or citrus trees. This set is equipped with an hydraulic system that allows you to control the hood's height from your seat cabin.





► **RECOMENDACIONES / RECOMMENDATIONS**

Cultivos / Crops	Viña y frutales de hueso / Vineyard and stone fruit trees
Marco de plantación / Plantation framework	Entre/ Between 2,4 - 5 m
L/ha	15 - 40 L/ha
Velocidad / Speed	3 - 7 km/h

► **HAZ TU COMPOSICIÓN / MAKE YOUR COMPOSITION**

DEPÓSITO Tank	IZQUIERDA Left	DERECHA Right	CAJA DE CONTROL / CABLES DE ALIMENTACIÓN / CAMPANA+BRAZO Control panel for debit / Set of power cables / Hood+arm
<p>100L Ref. 11797</p> 	<p>Ø 50cm Ref. 11798</p>	<p>Ø 50cm Ref. 11804</p>	
	<p>Ø 80cm Ref. 11805</p>	<p>Ø 80cm Ref. 11806</p>	
	<p>Ø 120cm Ref. 11807</p>	<p>Ø 120cm Ref. 11808</p>	

► **KIT ADAPTADOR / ADAPTER KIT**

Ref. 11810	
------------	--

* Necesario para acoplar las campanas con otros depósitos / It is necessary for couple the hoods with other tanks



PULMIC.
TAKE CONTROL

PULMIC FENIX TRACK

3049



Estos pulverizadores de Ultra Bajo Volumen, sirven para la aplicación de diferentes soluciones agroquímicas bajo el sistema CDA (Tamaño de Gota controlada).

A Fenix Track se le puede incorporar, mediante un sistema telescópico, campanas de aplicación de diferentes diámetros. La función telescópica habilita la Fenix Track para trabajar en diferentes cultivos con distintos marcos de plantación como son almendros, nogales, avellanos, olivos, cítricos, etc.

These Ultra Low Volume Sprayers are used for the application of different agrochemical solutions under the CDA system (Controlled Droplet Size).

The main dome can be adapted to your plot frame width, from 3m to 5m planting lines. Apart from that, the Fenix Track 3049 can even reach 7m width, by adding two extra 1,2m hoods. Because of that, it can be used at traditional planting frames such as vineyard, almond's trees, walnut, hazelnut, olive groves, citrus or other fruit's trees.



Ref:2635

PULMIC FENIX



► RECOMENDACIONES / RECOMMANDATIONS

Cultivos / Crops	Frutales / Fruit trees
Marco de plantación / Plantation framework	Entre 3-7 m
L/ha	15 - 40 L/ha

VENTAJAS

- Gran ahorro de agua.
- Ahorro de tiempo.
- Distribución uniforme de las gotas.
- Ausencia de deriva.
- Eficacia química mejorada del tratamiento.
- Aumento de la productividad.

ADVANTAGES



- Water saving
- Time saving
- Uniform distribution of the droplets.
- Drift absence.
- Improved chemical efficacy of treatment.
- Increased productivity.

ESPECIFICACIONES / SPECIFICATIONS

Tiempo de tratamiento con depósito de 200 litros. 20 L/ha. * Treatment time with 200 litres deposit. 20 L/ha. *	200 min
Hectáreas cubiertas con 200 litros. Hectares covered with 200 litres.	10 ha
Velocidad de avance Treatment speed	3 - 6 km/h
Peso del equipo Weight of equipment	204 kg

* Velocidad 5 km/h - Speed 5 km / h.



MODELO Model	DEPÓSITO Tank (Litros / Liters)	P.V.P(€) *
 PULMIC FENIX 75/100	75L Ref. 10620	
	100L Ref. 10953	
 PULMIC FENIX COMPACT 100	100L Ref. 11797	
 PULMIC FENIX TRACK 3049	200L Ref. 2635	



Ø CAMPANAS / Hoods		Marco de plantación Plantation framework	Caudal Flow (L/ha)	P.V.P.(€) *
Izquierda Left	Derecha Right			
Ø 50cm Ref. 10613	Ø 50cm Ref. 10614	1,5-3 m	15-50	
Ø 80cm Ref. 10615	Ø 80cm Ref. 10616	1,5-3 m	15-50	
Ø 50cm Ref. 11798	Ø 50cm Ref. 11804	2,4-5 m	15-50	
Ø 80cm Ref. 11805	Ø 80cm Ref. 11806	2,4-5 m	15-50	
Ø 120cm Ref. 11807	Ø 120cm Ref. 11808	2,4-5 m	15-50	
		3-7 m	15-40	



PULMIC®

TAKE CONTROL

Ref. 11833 ES-EN



GRUPOSANZ

www.gruposanz.es - info@gruposanz.es



Pulmic



gruposanz



gruposanz