

**TRINCIA
BROYEUR
SHREDDER
HÄCKSLER
DESBROZADORA
ИЗМЕЛЬЧИТЕЛЬ**

FALC[®]

ZENIT



FALC[®]

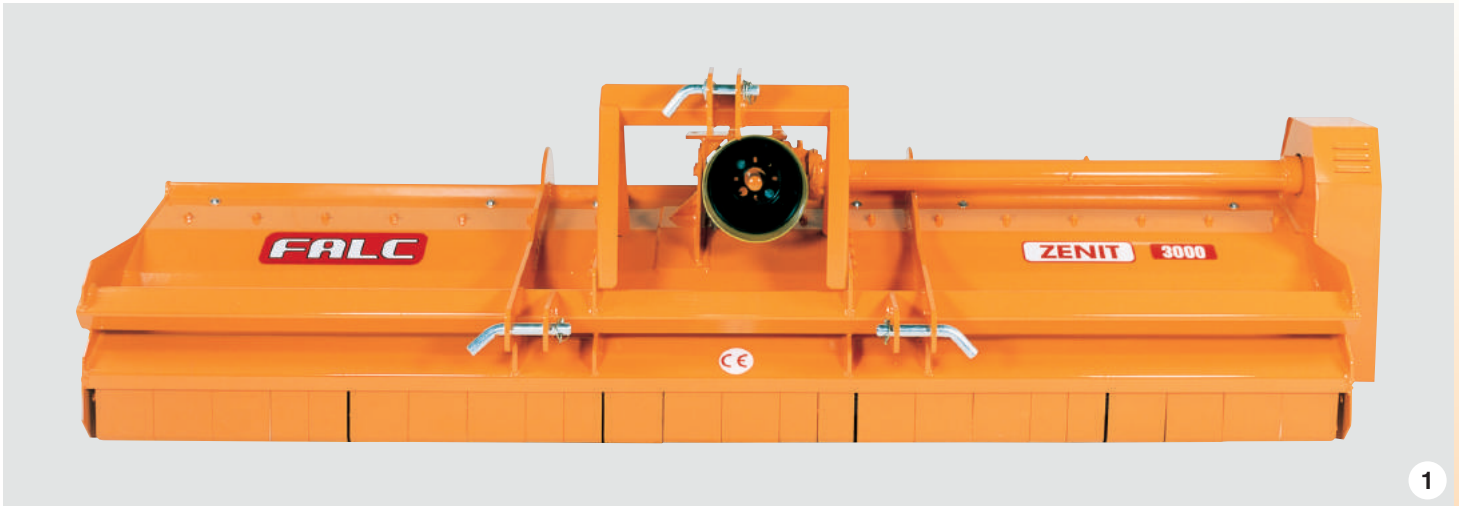

	Attacco fisso centrale.		Zentraler-Dreipunktbau.
	Attelage fixe central.		Enganche fijo central.
	Central fix linkage.		Фиксированное центральное крепление.

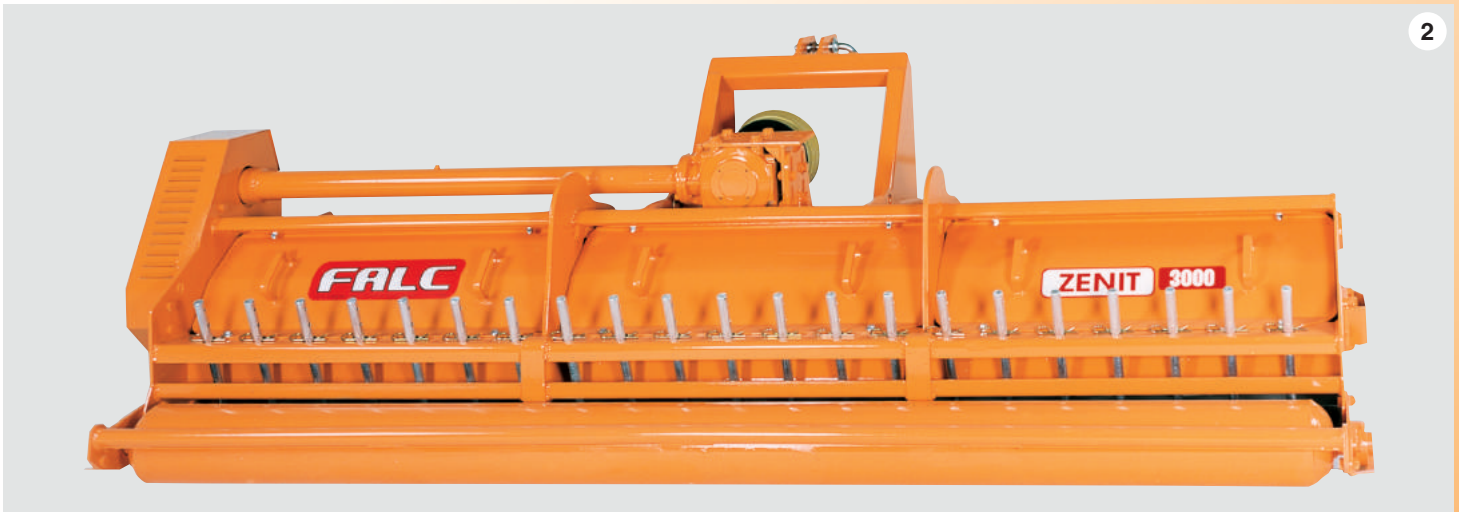

ZENIT FISSO ZENIT SPOSTABILE								ZENIT FISSO		ZENIT SPOSTABILE		G/M del rotore T/M du rotor Rotor's RPM Rotor U/M R/M de rotor Об/Мин. ротора
	A mm.	B mm.	A inches	B inches				N.	PTO	HP	KG	
1600	1585	1859	62,40	73,18	16	540 *	50 - 90	595	1312	660	1455	2250
1800	1765	2039	69,48	80,27	18	540 *	50 - 90	630	1389	720	1587	2250
2100	2125	2399	83,66	94,44	22	540 *	50 - 90	720	1587	800	1764	2250
2300	2305	2549	90,74	100,35	24	540 *	60 - 90	800	1764	850	1874	2250
2500	2485	2759	97,83	108,62	26	540 *	60 - 90	870	1918	910	2006	1822
2700	2665	2939	104,92	115,70	28	540 *	60 - 90	950	2094	990	2183	1822
3000	3025	3299	119,09	129,88	32	540 *	60 - 90	1020	2249	1090	2403	1822

	ZENIT/F: i pesi sono con lamiera d'usura ZENIT/SP: i pesi sono con lamiera d'usura, con ruote anteriori		ZENIT/F: die Gewichte einschließen Verschleißblech ZENIT/SP: die Gewichte einschließen Verschleißblech und Vorderrädern
	ZENIT/F: les poids sont avec tôle d'usage ZENIT/SP: les poids sont avec tôle d'usage, avec roues avant		ZENIT/F: los pesos son con lamina de desgaste ZENIT/SP: los pesos son con lamina de desgaste, con ruedas anteriores
	ZENIT/F: the weights include wear and tear sheet ZENIT/SP: the weights include wear and tear sheet, front wheels		ZENIT/F: вес с листовым износом ZENIT/SP: вес с листовым износом, с передними колесами

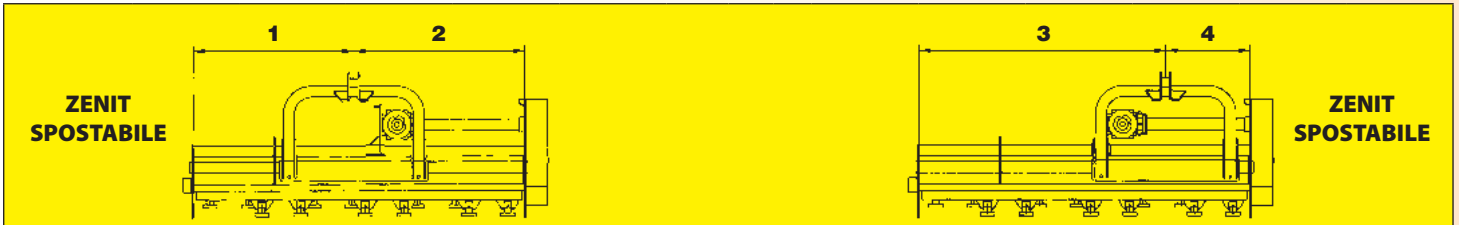
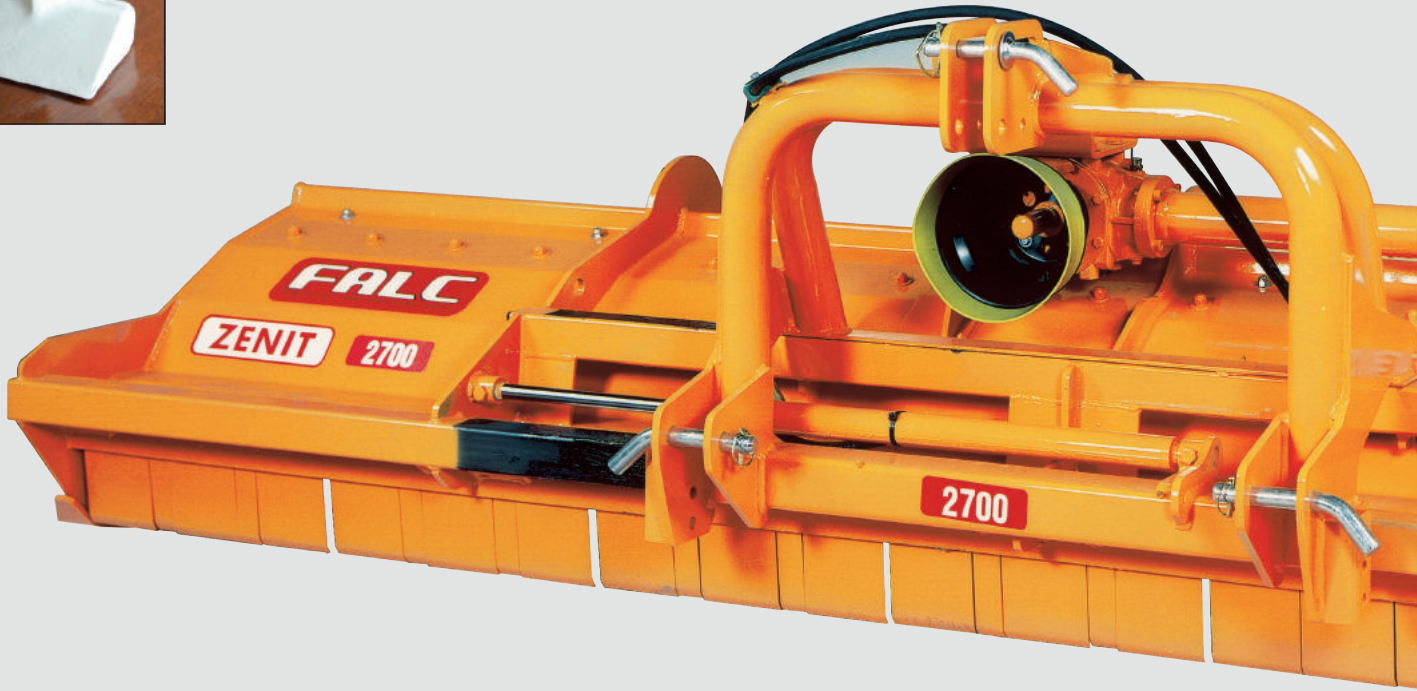

SERIE	1 + 2 =			1 + 2 =			3 + 4 =			3 + 4 =		
	mm.	mm.	mm.	inches	inches	inches	mm.	mm.	mm.	inches	inches	inches
1600	733	852	1585	28,85	33,54	62,40	1333	252	1585	52,48	9,92	62,40
1800	913	852	1765	35,94	33,54	69,48	1513	252	1765	59,56	9,92	69,48
2100	1273	852	2125	50,11	33,54	83,66	1873	252	2125	73,74	9,92	83,66
2300	1258	1047	2305	49,52	41,22	90,74	1858	447	2305	73,15	17,59	90,74
2500	1298	1187	2485	51,10	46,73	97,83	1898	587	2485	74,72	23,11	97,83
2700	1368	1297	2665	53,85	51,06	104,92	1968	697	2665	77,48	27,44	104,92
3000	1588	1437	3025	62,52	56,57	119,09	2188	837	3025	86,14	32,95	119,09

ZENIT Stone Line



Esiste la versione per terreni sassosi: I perni porta martelli standard ①, sono sostituiti dai perni ②. I due supporti del rotore sono speciali.



Es gibt die Version für Steinboden: die Standard Bolzen für Hämmer ① sind mit die Sonderbolzen ② ersetzt die zwei Rotorhalter sind besondere.



Il y a la version pour terrain caillouteux: Les axes porte marteaux standard ① sont remplacés par les pivots ②. Les deux supports du rotor sont spéciaux.



Existe la version para terrenos pedregosos: Los pernos porta martillos standard ① son sustituidos por pernos ②. Los dos soportes del rotador son especiales.



There is a version for stony soils: the standard hammer holder pins ① have been replaced by the pins ②. The two rotor supports are special.



Существует версия для каменистых почв: Штифты поддерживающие стандартные молотки ①, заменены штифтами ②. Две опоры ротора являются специальными.

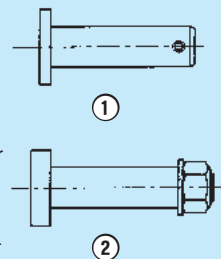

3

-  Spostamento idraulico cm 60
-  Déplacement hydraulique cm 60
-  Hydraulic offset cm 60 (inches 23,62)
-  Hydraulischer Verschiebung cm 60
-  Desplazamiento hidráulico cm 60
-  Гидравлическое перемещение 60 см

-  * A RICHIESTA: P.T.O. 1000 G/M.
-  * SUR DEMANDE: P.D.F. 1000 T/M.
-  * ON REQUEST: P.T.O. 1000 RPM.
-  * AUF WUNSCH: P.T.O. 1000 U/M.
-  * A PEDIDO: T.D.F. 1000 V/M.
-  * ПО ЗАПРОСУ: В.О.М. 1000 Об/Мин

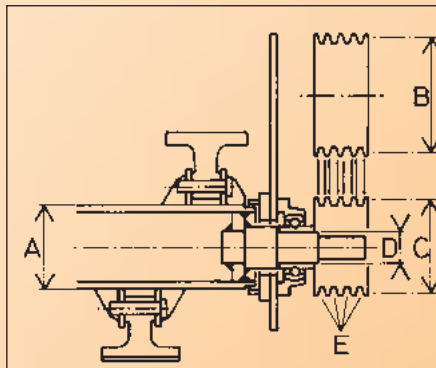

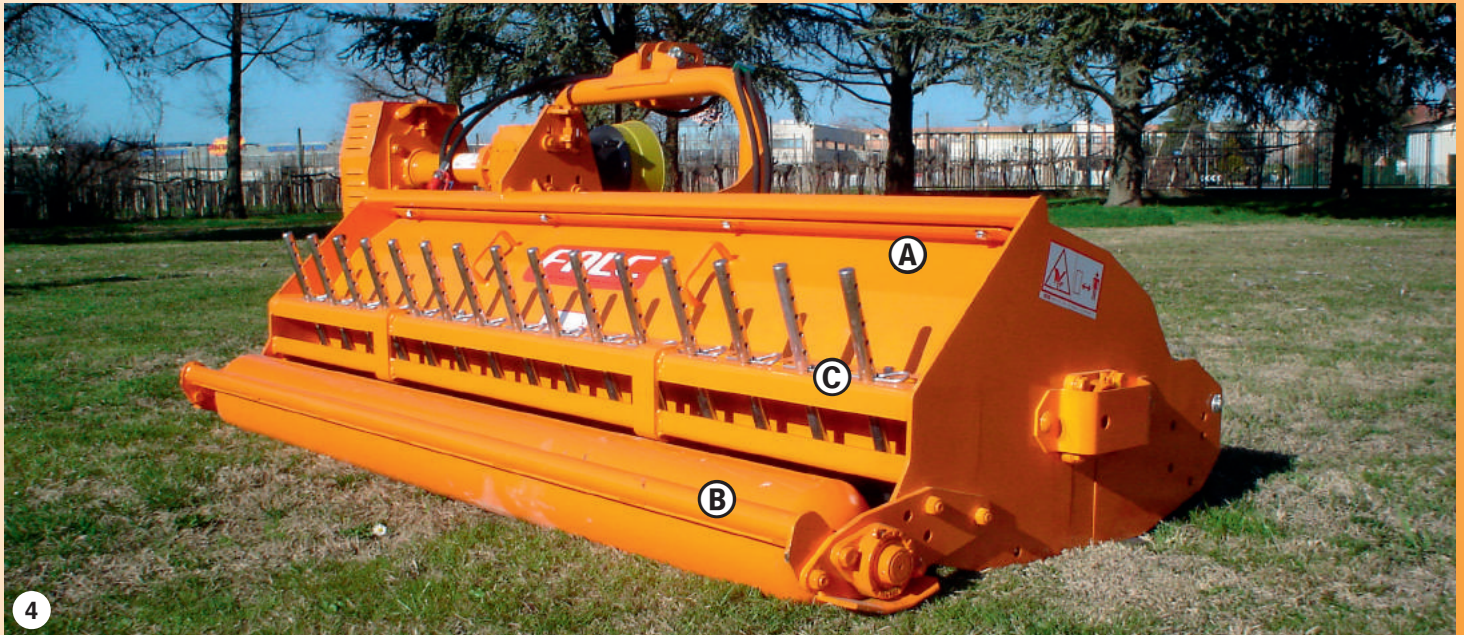
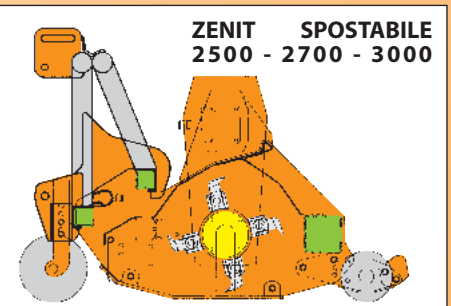
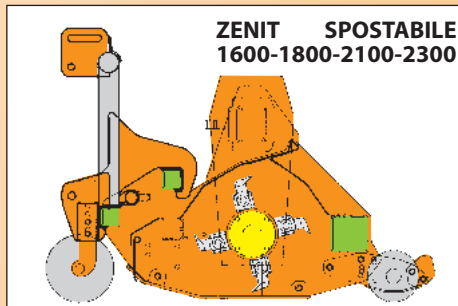

- A) Ø mm. 193,7 inches 7,63
- B) Ø mm. 250 inches 9,84
(1400-1600-1800-2100-2300)
- B) Ø mm. 225 inches 8,86
(2500-2700-3000)
- C) Ø mm. 180 inches 7,09
(1400-1600-1800-2100-2300)
- C) Ø mm. 200 inches 7,87
(2500-2700-3000)
- D) Ø mm. 50 inches 1,97
- E) N° 3 MOD. 1400
N° 4 MOD. 1600-1800-2100-2300
N° 5 MOD. 2500-2700-3000



4

 Di serie: **A** cofano apribile per manutenzione. **B** rullo posteriore. **C** predisposizione per rastrello







 Equipé de serie avec: **A** capot de fermeture pour entretien. **B** rouleau postérieur. **C** disposition pour râtelier.

 Serial equipped with: **A** closing bonnet for maintenance. **B** rear roller. **C** facility for rake.

 Serienmäßige Ausrüstung: **A** zu öffnende Schließhaube für Wartung. **B** hintere Stützwalze. **C** Vorbereitung für Rechen.

 De serie: **A** capot abridero para manutención. **B** rodillo posterior. **C** predisposición para rastrelladora

 Серии: **A** капот открывается для обслуживания. **B** ролик сзади. **C** предрасположение для граблей.

-  Trincia versatile ideale per aziende agricole con colture diversificate.
-  Broyeur universel, idéal pour exploitations agricoles à cultures diversifiées.
-  Versatile shredder, ideal for different crops farms.
-  Vielseitiger Häcksler, ideal für den Einsatzbereichen der Landwirtschaft.
-  Desbrozadora polivalente ideal para haciendas agrícolas con cultivos diversificados.
-  Универсальный измельчитель идеально подходит для хозяйств с различными посевами.

A richiesta:

- Ruote anteriori in ferro
- Ruote sterzanti posteriori in gomma
- Lamiera d'usura
- Secondo controcoltello

Sur demande:

- Roues antérieures en fer
- Roues postérieures braquantes en gomme
- Tôle d'usura
- Deuxième contre couteau

On request:

- Front iron wheels
- Rear steering wheels (tires)
- Wear and tear sheet
- Second counter blade

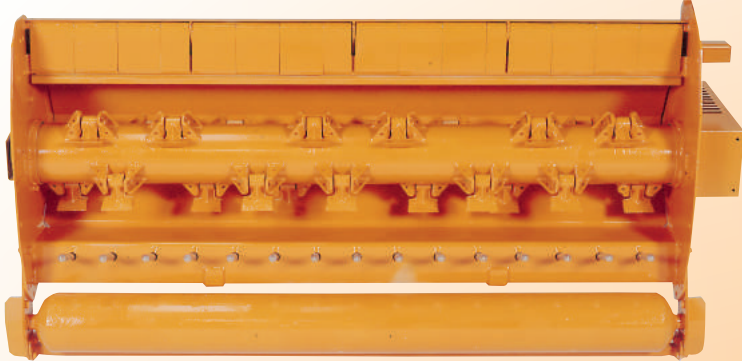

5

Sonderausstattung:







- Metallräder vorne
- Steuernde Räder hinten
- Verschleißblech
- 2 Reihe Gegenmesser

A pedido:

- Ruedas anteriores en hierro
- Ruedas posteriores de goma
- Chapa de desgaste
- Segunda contracuchilla

По запросу:

- Передние колеса железные
- Задние рулевые колеса резиновые
- Листовой износ
- Второй контрнож

-  **Per la trinciatura delle erbe, dei residui delle potature, dei residui vegetali in genere come mais, sorgo, girasole, soia, ecc.**
-  **Pour le broyage des herbes, sarments, résidus végétaux en général comme mais, sorgho, soja, tournesol, etc.**
-  **For the chopping of grass, prunings, vegetal residuals in general such as maize, sorghum, sunflowers, soy, etc.**
-  **Für das Häckseln von Gras/Weideflächen, Pflanzenresten wie Mais/Hirse/Soja oder Sonnenblumen.**
-  **Para trincar hierbas, residuos de poda, restos vegetales en general como maíz, sorgo, girasol, soja, etc.**
-  **Для измельчения травы, остатков срезанных веток, растительных остатков, таких как кукуруза, сорго, подсолнечник, соя и т.д.**





- TRINCIA SPECIALE CON SPOSTAMENTO IDRAULICO (cm 40) PER FILARI STRETTI**
- BROYEUR SPECIAL AVEC DEPLACEMENT HYDRAULIQUE (cm. 40) POUR RANGEES ETROITES**
- SPECIAL SHREDDER WITH HYDRAULIC OFFSET (cm. 40 - Inches 15,75) FOR NARROW ROWS**
- SONDER HÄCKSLER MIT HYDRAULISCHEN VERSCHIEBUNG (cm. 40) FÜR ENGE LAGE**
- DESBROZADORA ESPECIAL CON CAMBIO HIDRAULICO (cm.40) PARA PERFILES ESTRECHOS**
- СПЕЦИАЛИЗИРОВАННЫЙ ИЗМЕЛЬЧИТЕЛЬ С ГИДРАВЛИЧЕСКИМ ПЕРЕМЕЩЕНИЕМ (40 см) ДЛЯ УЗКИХ РЯДОВ**

8

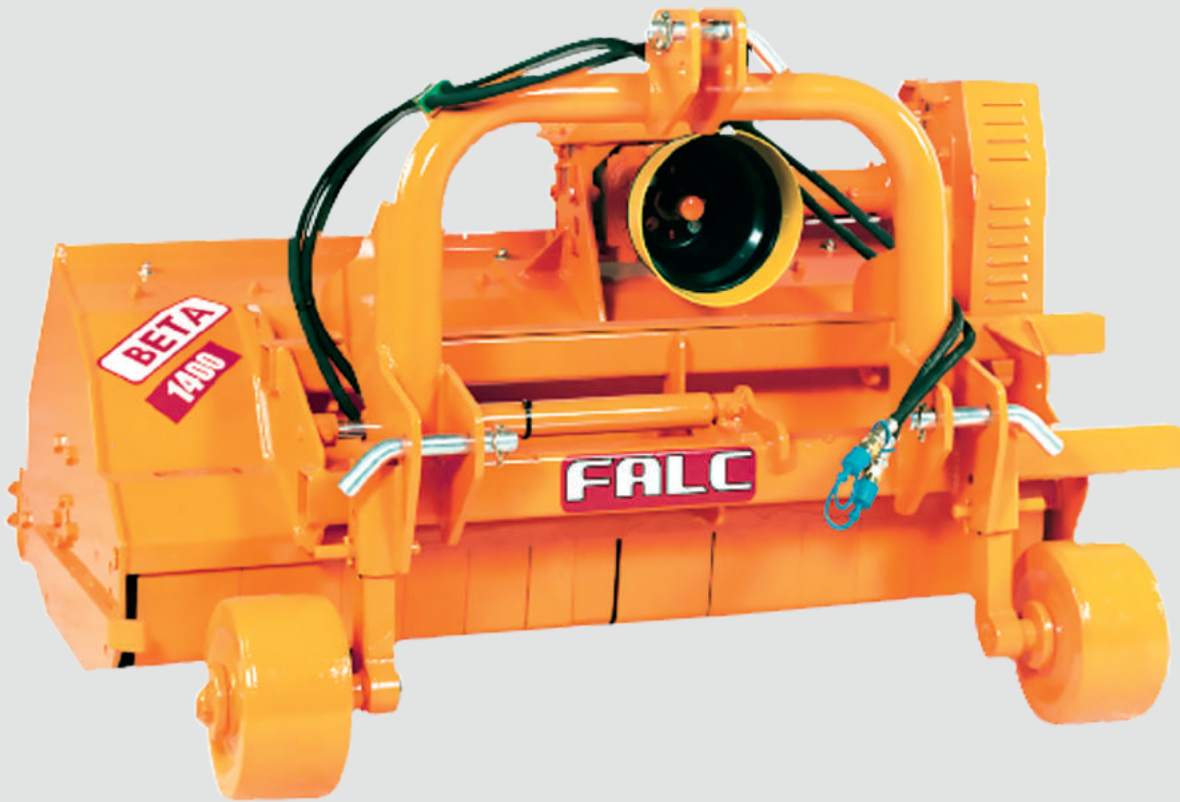

BETA									
	A mm.	B mm.	A inches	B inches	PTO	HP	KG	LBS	N.
1200	1225	1409	48,22	55,47	540	50 - 90	540	1190	12
1400	1405	1589	55,31	62,55	540	50 - 90	610	1345	14

FALC - Via Proventa, 41 - 48018 FAENZA (ITALIA) - e-mail: info@falc.eu - www.falc.eu

Tel. +39 0546 29050
Fax +39 0546 663986

